INTRODUCTION

This manual contains detailed instructions on the operation and maintenance of this machine. To get the maximum versatility from this machine, all operators should carefully read and follow the instructions in this manual. Please keep this manual in a handy place near the machine.

Please read the next section before using this machine. It contains important information related to USER SAFETY and PREVENTING EQUIPMENT PROBLEMS.

SAFETY INFORMATION

When using your machine, the following safety precautions should always be followed.

Safety During Operation



In this manual, the following important symbols are used:



 **WARNING:** *Ignoring this warning could cause serious injury or even death.*

 **CAUTION:** *Ignoring this caution could cause injury or damage to property.*

Examples Of Indications

 Symbols  means a situation that requires you take care.

 Do **NOT** carry out the operation represented by the symbol . This example means "Do not take apart".

 Symbols  means you **MUST** perform this operation. This example means "You must remove the wall plug".

⚠ WARNINGS:

- *Only connect the machine to the power source described on the inside front cover of this manual. Avoid multi-wiring as it could cause an electric shock or a fire.*
- *Avoid using an extension cord. Make sure the wall outlet is near the machine and freely accessible so that in event of an emergency it can be unplugged easily.*



- *Do not damage, break or make any modifications to the power cord. Do not place heavy objects on it, pull it hard or bend it more than necessary. These actions could cause an electric shock or fire.*



- *Do not remove any covers or screws other than those specified in this manual. Some parts of the machine are at a high voltage and could give you an electric shock. When the machine needs to be checked, adjusted or repaired, contact your service representative.*
- *Do not take apart or attempt any modifications to this machine. There is a risk of fire, electric shock, explosion or loss of sight.*



- *If the machine looks damaged or breaks down, smoke is coming out, there is a strange smell or anything looks unusual, immediately turn off the main power switch then unplug the power cord from the wall. Do not continue using the machine in this condition. Contact your service representative.*



- *Do not put any metal objects or containers holding water (e.g. vases, flowerpots, glasses) on the machine. If the contents fall inside the machine a fire or electric shock could occur.*



- *If any metal, liquid or foreign matter falls into the machine, turn off the main switch and unplug the main power cord. Contact your service representative. Do not keep using the machine with a fault or defect.*



- ***Do not plug or unplug the power cord with wet hands or an electric shock might occur.***

**CAUTIONS:**

- ***When you move the machine, unplug the power cord from the wall outlet to avoid fire or electric shock.***

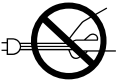

- ***When you pull out the plug from the socket, grip the plug to avoid damaging the cord and causing fire or electric shock.***



- ***Keep the machine away from humidity and dust. A fire or an electric shock might occur.***
- ***Do not place the machine on an unstable or tilted surface. If it topples over it could cause injury.***



- ***When the machine will not be used for a long time, unplug the power cord.***



- ***If you use this machine in a confined space, make sure there is a continuous air turnover.***



- ***This machine has been tested for safety using this supplier's parts and consumable. We recommend you only use these specified supplies.***

GUIDE TO COMPONENTS

Machine Exterior

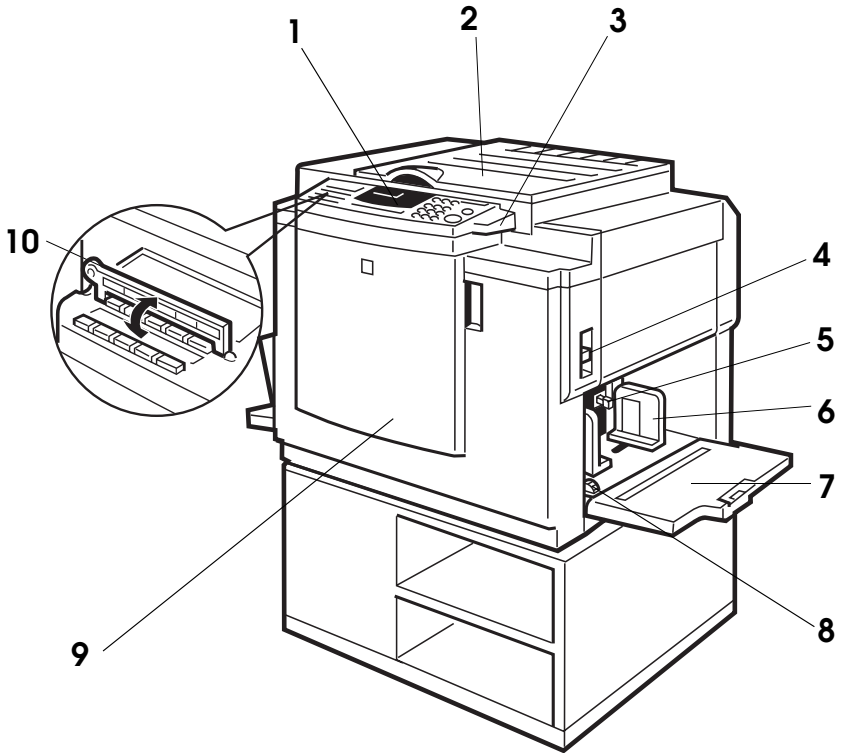

1. **Operation panel** Operator controls and indicators are located here. ➡ See pages 5 ~ 7.
2. **Platen cover** Lower this cover over an original before printing.
3. **Original table release lever** Use to open the original table unit when installing the master.
4. **Feed roller pressure lever** Use to adjust the contact pressure of the paper feed roller according to paper thickness.
5. **Separation roller pressure lever** Use to adjust the separation roller pressure to prevent double feed.
6. **Paper feed side plates** Use to prevent paper skew.
7. **Paper feed table** Set paper on this table for printing.
8. **Side plate fine adjusting dial** Use to shift the paper feed table sideways.
9. **Front cover** Open to access to the inside of the machine.
10. **Plate** Flip over when you use One Touch Class function. ➡ See page 47.

Machine Interior

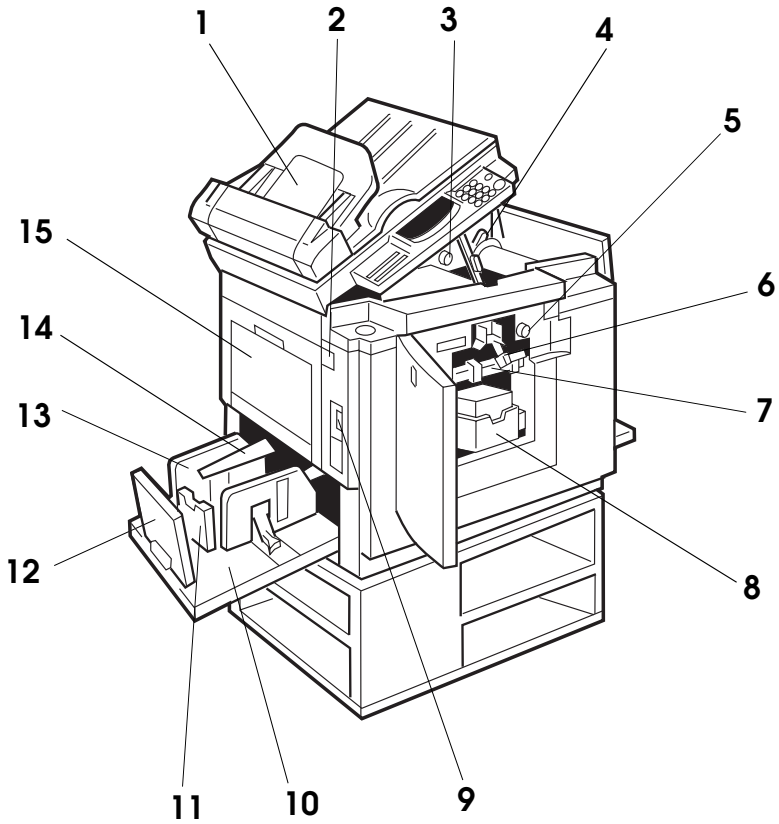

1. **Document feeder (Option)** Original inserted into the document feeder are individually and automatically fed onto and removed from the exposure glass. ➔ See page 82.
 2. **Master eject unit open button** Press to remove misfed paper or a misfed master.
 3. **Master cut button** Press this button to cut the master leading edge after installing a new master roll.
 4. **Pressure release lever** Use to install the master roll.
 5. **Drum rotation button** Press to rotate the drum unit.
 6. **Drum unit lock lever** Lift to unlock and pull out the drum unit.
 7. **Drum unit** The master is wrapped around this unit.
 8. **Ink holder** Set the ink cartridge in this holder.
 9. **Main switch** Use to turn the power on or off.
 10. **Paper delivery table** Completed prints are delivered here.
 11. **Small size paper delivery end plate** Use to align the leading edge of prints that are A4, 8 1/2" x 11" or smaller.
 12. **Paper delivery end plate** Use to align the leading edge of prints larger than A4, 8 1/2" x 11".
 13. **Paper delivery side plate** Use to align the prints on the paper delivery table.
 14. **Wing guides** When printing on thin or small size paper, lift these guides. ➔ See page 15.
 15. **Master eject container cover** Open when removing the master eject box.
- Other options: Color Drums (red, blue, green, brown, yellow, purple, navy, maroon, orange and teal)
Tape Dispenser
Key Counter
Cabinet

Operation Panel

Keys

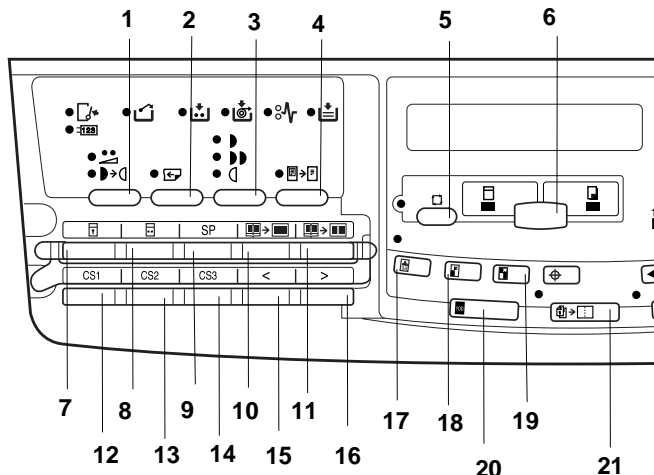

1. Economy/Tint key

☞ See pages 42 ~ 44.

2. Skip Feed key

☞ See page 71.

3. Image Density key

☞ See page 23.

4. Paste Shadow Erase key

☞ See page 36.

5. Auto Cycle key

☞ See page 45.

6. Master Making/Print key

Press to select Master Making or Print mode.

7. Security key

☞ See page 79.

8. Quality Start key

☞ See page 80.

9. SP mode key

☞ See page 94.

10. Edge Erase key

☞ See page 34.

11. Edge Erase/Center Erase key

☞ See page 31.

12. 13. 14. CS mode keys

☞ See pages 97 ~ 101.

15. 16. Scroll keys

Press to select size and direction of paper or original in Edge Erase/Center Erase and Edge Erase function.

Press to select the mode in Service Program mode.

17. Type of Original key

☞ See page 40.

18. Reduce key

☞ See page 27.

19. Enlarge key

☞ See page 29.

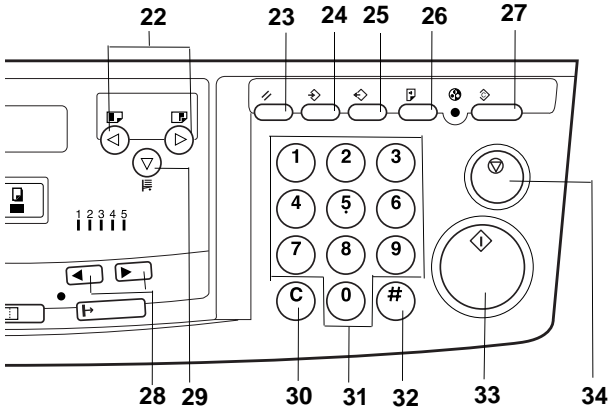
**20. Full Size key**

Press to make full size prints.

21. Combine 2 Originals key

☞ See page 63.

22. Image Position keys

☞ See page 21.

23. Reset key

Press to reset the error indicators.

24. Program Class key

☞ See page 47.

25. Program key

☞ See page 73.

26. Proof key

Press to make proof prints.

27. Clear Modes key

Press to cancel all previously entered settings.

28. Speed keys

☞ See page 24.

29. Lower key

Press to lower the paper feed table.

30. Clear key

Press to change the number set.

31. Number keys

Press to enter the number of prints and data.

32. Enter key

Press to input data into memory.

33. Start key

Press to start making of a master or printing.

34. Stop key

Press to stop the machine operation.

Indicators

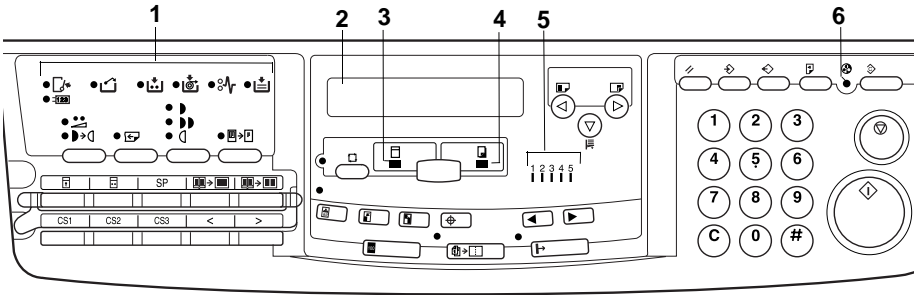

1. Error indicators

These indicators are lit when a non-standard condition occurs within the machine. ➔ See page 128.

2. Guidance Display

Press to stop the machine operation.

3. Master Making indicator

This indicator is lit when Master Making mode is selected.

4. Print indicator

This indicator is lit when Print mode is selected.

5. Speed indicators

These indicators show the printing speed that is selected. ➔ See page 24.

6. Color Drum indicator

This indicator is lit when the optional color drum unit is set. ➔ See page 88.

INSTALLATION REQUIREMENTS

The machine's location should be carefully chosen because environmental conditions can affect its performance.

Optimum Environmental Conditions

- ❑ Temperature: 10 - 30°C, 50 - 86°F
- ❑ Humidity: Main frame: 20 - 90 % RH
Document feeder (option): 20 - 70 % RH
- ❑ A strong and level base (A sturdy desk and cabinet etc.).
- ❑ The machine must be level within 5 mm (13/64") both front to rear and left to right.
- ❑ Make sure to locate this machine in a large well ventilated room that has an air turnover of more than 30 m³/hr/person.

Environments To Avoid

- ❑ Direct sunlight or strong light (more than 1500 lux).
- ❑ Locations directly exposed to cool air from an air conditioner or heated air from a heater. (Sudden temperature changes from low to high or vice versa may cause condensation within the machine.)
- ❑ Dusty areas.

Access To The Machine

- ❑ Place the machine near a power source, providing clearance as shown.

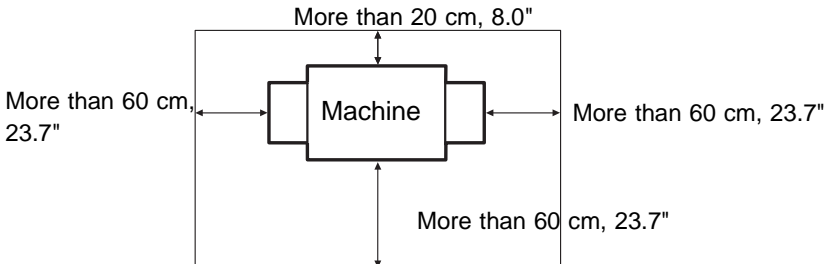

Power Connection



WARNING:

- ***Only connect the machine to the power source described on the inside front cover of this manual.
Avoid multi-wiring as it could cause an electric shock or a fire.***
- ***Avoid using an extension cord. Make sure the wall outlet is near the machine and freely accessible so that in event of an emergency it can be unplugged easily.***
- ***Do not damage, break or make any modifications to the power cord. Do not place heavy objects on it, pull it hard or bend it more than necessary. These actions could cause an electric shock or fire.***



CAUTION:

- ***When you move the machine, unplug the power cord from the wall outlet to avoid fire or electric shock.***
- ***When you pull out the plug from the socket, grip the plug to avoid damaging the cord and causing fire or electric shock.***

- Make sure the plug is firmly inserted in the outlet.
- Avoid multiwiring.
- Do not pinch the power cord.

OPERATION

Printing Paper

- ❑ The following types of print paper are not recommended for this machine.
 - Paper smaller than 90 mm x 148 mm, 3.6" x 5.9"
 - Paper larger than 297 mm x 432 mm, 11.6" x 17.0"
 - Paper heavier than 209.3 g/m², 55.6 lb
 - Paper lighter than 47.1 g/m², 12.5 lb
(However, 45 g/m², 11.9 lb paper may be used when the printing speed is setting 1, 2 or 3 and the separation pressure levers are in the "Thick" position.)
 - Roughly-cut paper
 - Paper of different thickness in the same stack
 - Buckled or curled paper
 - Short grain paper
 - Low stiffness paper
- ❑ Correct curls in the paper before setting it in the machine. When you cannot correct the paper curl, stack the paper with the curl face down. Otherwise the paper might wrap around the drum or stains might appear.
- ❑ Store paper where it will not curl or absorb moisture. Use paper soon after it is unpacked.
- ❑ Only use paper where the leading edge has two right angle corners, as shown below.

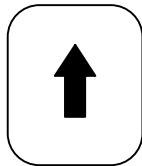

Not OK

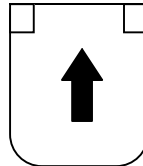

OK

Originals

- Originals that can be set on the exposure glass are as follows:
 - Maximum size: 257 x 364 mm, 10.2" x 14.4"
 - Maximum total thickness: 30 mm, 1.1"
 - Maximum total weight: 5 kg, 11.0 lb
- If you use paste-up originals, make sure the pasted parts hold firmly to the base sheet and press the **Paste Shadow Erase** key. If the thickness of the paste-up original is more than 0.1 mm and the space between the pasted parts is less than 2 mm, $2/25$ ", a shadow might appear on the prints.
- If you use originals that have bold letters or solid images at the leading edges, you might get prints with dirty edges. In this case, insert the widest margin first, or raise the printing speed.
- The first 5 mm, 0.2" of the leading edge cannot be printed. Make sure the leading edge margin is at least 5 mm, 0.2".

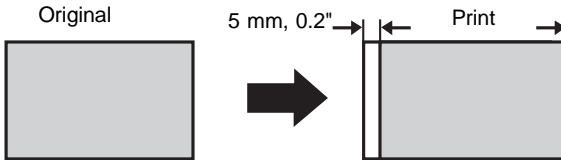

Preparation For Printing

1 Carefully open the paper feed table.

- Keep hold the paper feed table until it stops.

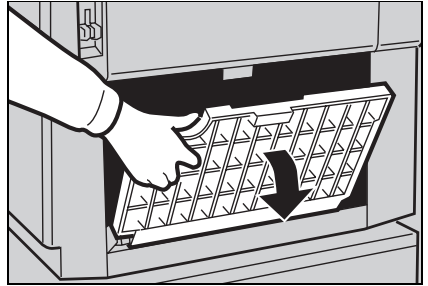

2 Adjust the side plates to match the paper size.

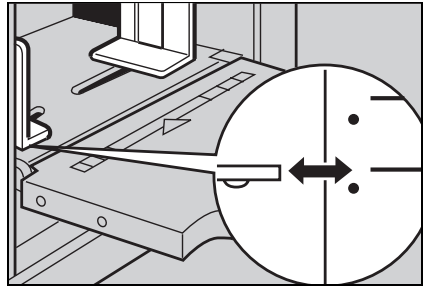

3 Place the paper on the paper feed table.

- Correct the paper curl before setting the paper. If you cannot do so, stack the paper with the curl face down as shown.

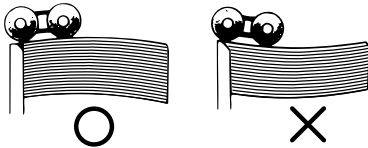
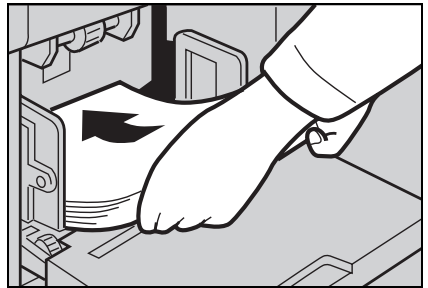

- 4 Make sure that the paper feed side plates contact the paper lightly.



Setting up the paper delivery table

- 5 Lift up the paper delivery table a little and then open it.

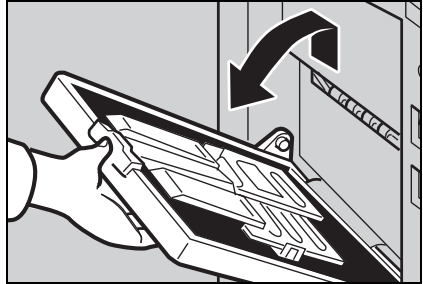

- 6 Lift the paper delivery end plate and move it to match the print paper size.

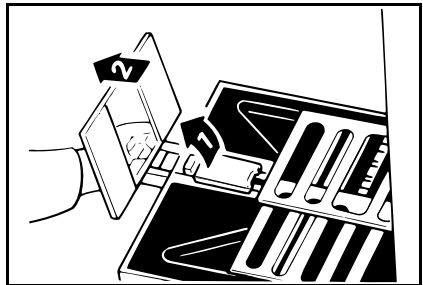

- 7** Lift the paper delivery side plates and adjust them to the paper size.

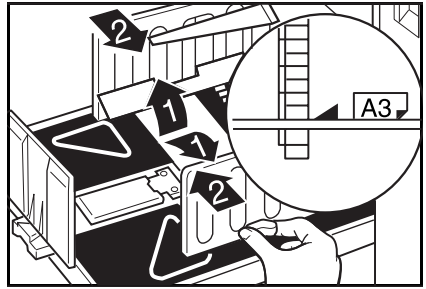

- 8** If you want to use A4, 8 1/2" x 11" or smaller paper, lift the small size paper delivery end plate and move it to match the print paper size.

- When you use B4, 8 1/2" x 14" size paper, you do not need to lift the small size paper delivery end plate.

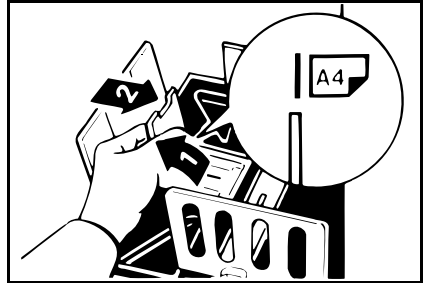

- 9** If necessary, lift the left and right wing guides.

- If you find paper is not delivered properly when printing on thin paper, make sure the wing guides are up.
- When printing on paper thicker than 81.4 g/m², 21.6 lb, do not lift up the wing guides.

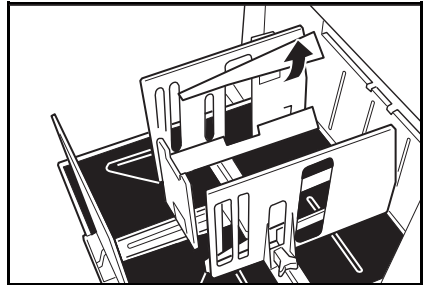

- 10** Turn on the main switch.



Setting the small size end plate prop

If A4, 8 1/2" x 11" or smaller paper is not delivered to the paper delivery table properly, set the small size end plate prop to the small size paper delivery end plate.

- 1** Set the small size end plate prop to the small size paper delivery end plate as shown in the illustration.

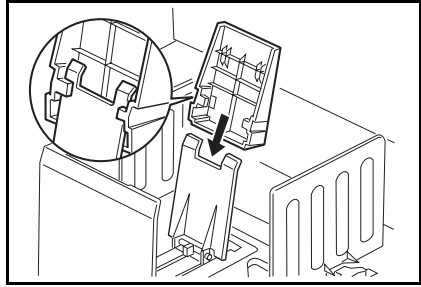

- 2** Slide the prop until it locks in position.

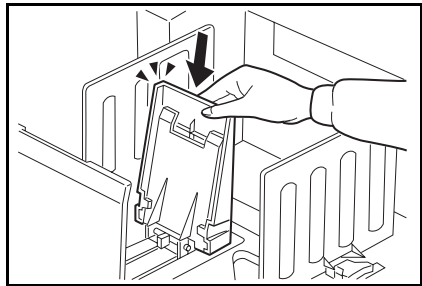

- 3** Adjust the main frame side of the prop to match the paper size.

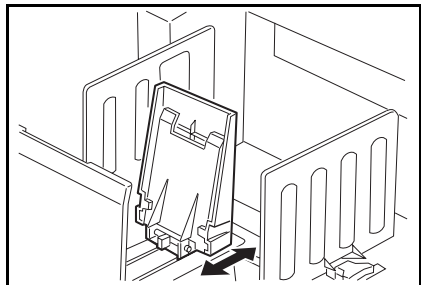

Standard Printing

- 1 Open the platen cover.

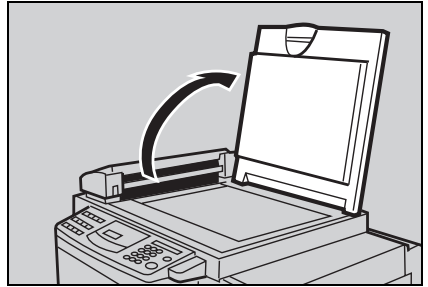

- 2 Place the original face down on the exposure glass. The original should be centered according to the size marks on the right scale.

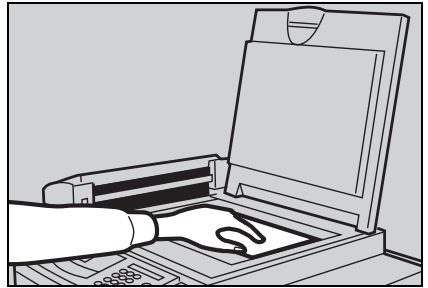

- 3 Lower the platen cover.

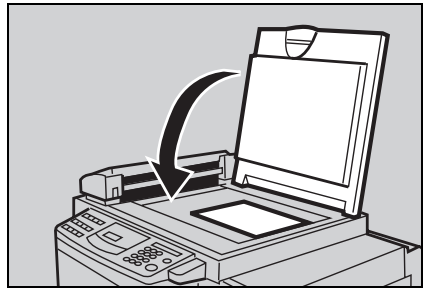

- 4 Make sure the **Master Making** indicator is lit. If not, press the **Master Making/Print** key and select the Master Making mode.

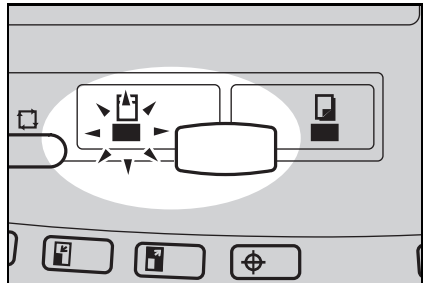

5 Press the **Start** key.

- A trial print is delivered to the paper delivery table.

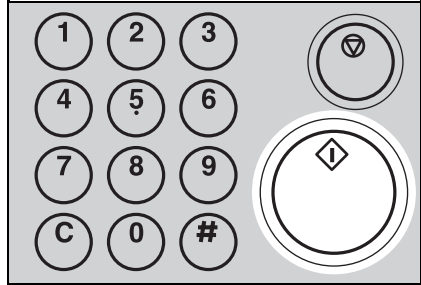

6 Press the **Proof** key and check the image density and the image position of the proof print.

- If the image position is not correct, adjust it using the **Image Position** keys or the fine adjustment dial. (See pages 21 and 22.)
- If the image density is slightly dark or light, adjust the image density by pressing the **Speed** keys. (See page 24.)

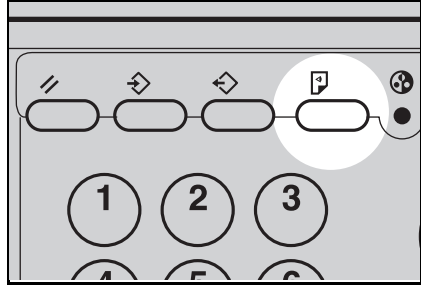

7 Enter the number of prints required using the **Number** keys.

- Up to 9999 prints can be entered at one time.
- To change the number entered, press the **Clear** key and then enter the new number.

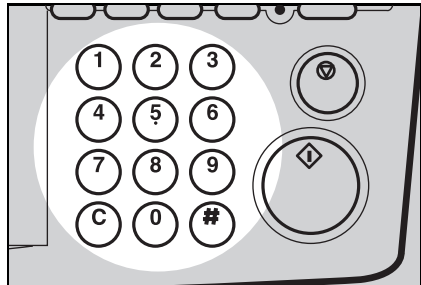

8 Make sure the **Print** indicator is lit and then press the **Start** key.

- After printing is completed, the same number of prints is automatically set for the next job.
- If you want to stop the machine during a print run, press the **Stop** key.

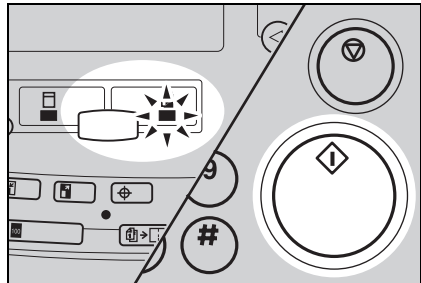

9 Remove the prints from the paper delivery table.

- To clear all the modes you have selected, press the **Clear Modes** key.

Restoring Paper Feed And Paper Delivery Tables

1 Remove the paper from the paper feed table.

- The paper feed table will lower.

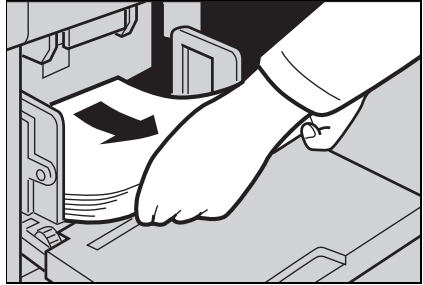

2 Turn off the main switch.



3 Close the paper feed table.

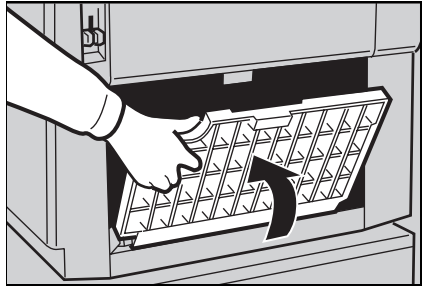

4 Push the small size paper delivery plate to the left, then lower it, if necessary.

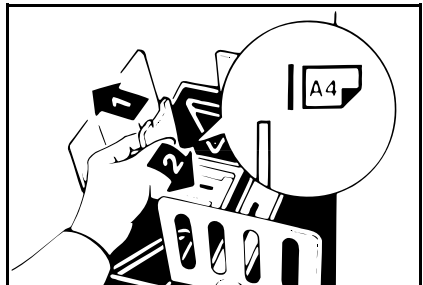

- 5** Return the left and right wing guides to their original positions, if necessary.

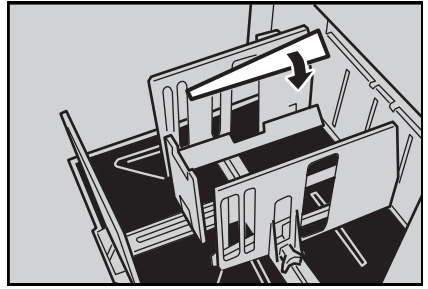

- 6** Move the side plates to the sides, then lower them.

- Make sure that the side plates do not touch the small size paper delivery end plate.

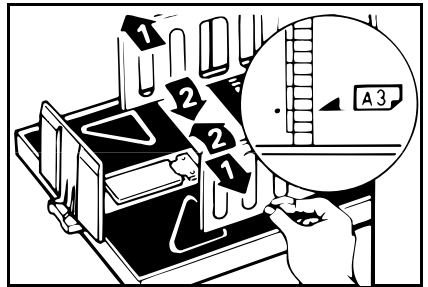

- 7** Move the end plate until the plate handle is flush with the end of the table.

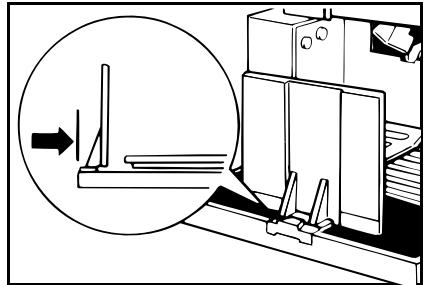

- 8** Lower the end plate.

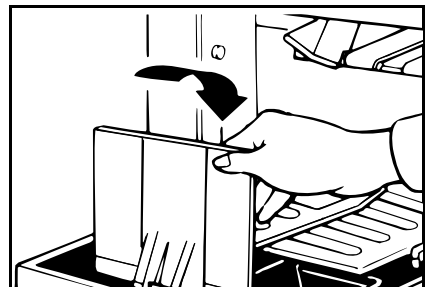

- 9** Close the table.

Adjusting The Image Position

Shifting the image position forward or backward

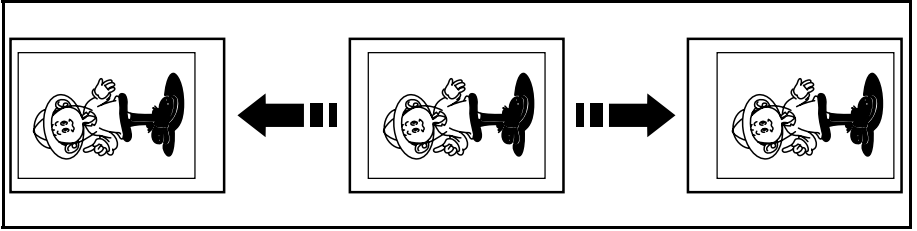

1 Press the right or left **Image Position** key.

- When you shift the image forwards, leave a margin (more than 5 mm, 0.2") at the leading edge. If there is no margin, paper might wrap around the drum and cause a misfeed.
- The right or left **Image Position** keys shift the image about 0.5 mm, 1/50" each time they are pressed. When the indicator changes, the image position shifts about 5 mm, 1/5".

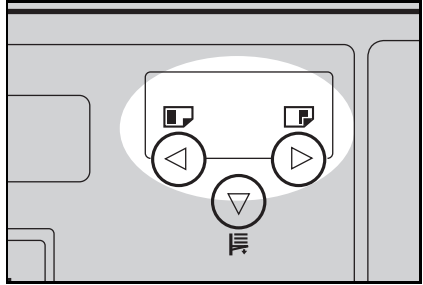

2 Press the **Proof** key. Check the image position again.

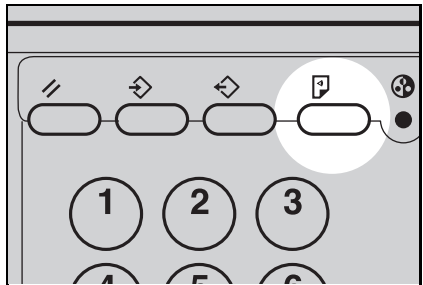

Shifting the image to the right or left

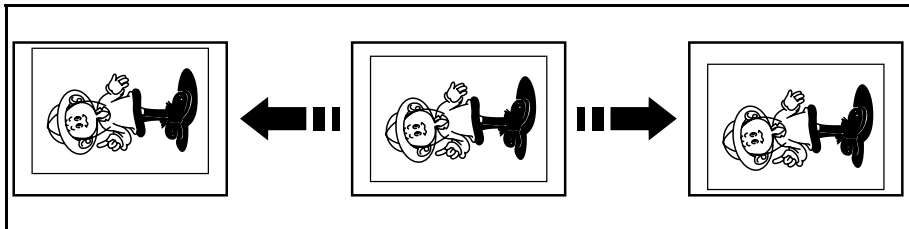

- 1** Turn the side plate fine adjusting dial as shown in the illustrations.

- The image position can be shifted up to about 10 mm, 2/5" each way. Each division on the scale is 2 mm, 0.08".

<Shifting the image to the right>

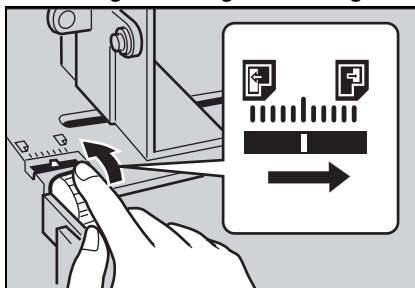

<Shifting the image to the left>

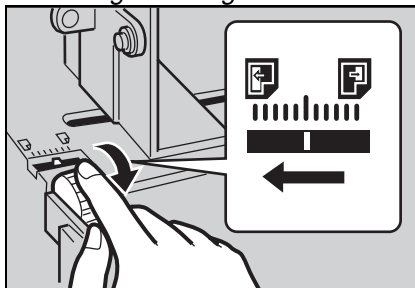

- 2** Adjust the paper delivery side plates to the print paper position.

- 3** Press the **Proof** key. Check the image position.

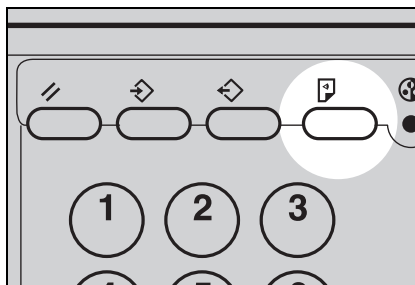

Adjusting The Image Density

Before making a master

- 1 Select the desired image density using the **Image Density** key.

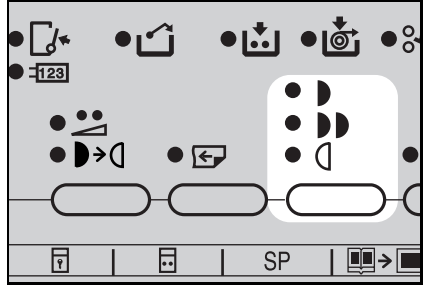

- 2 Make sure that Master Making indicator is lit and then press the **Start** key.

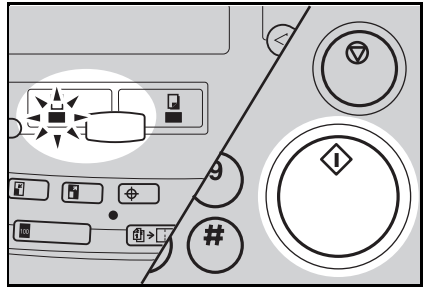

After making a master

- 1 Press the **Speed** keys. To increase the speed, press the “▶” key. To reduce the speed, press the “◀” key.

- The faster the printing speed becomes, the lighter the printing density is. If you want darker prints, decrease the printing speed.

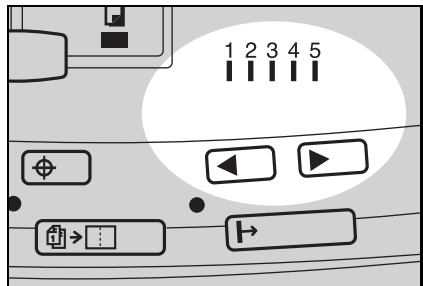

Changing The Printing Speed

Use the **Speed** keys to adjust the speed of the machine with the image density and printing paper.

Press the **Speed** keys. To increase the speed, press the “▶” key. To reduce the speed, press the “◀” key. The printing speed will be changed as follows:

Setting 1: 60 sheets/minute
Setting 2: 75 sheets/minute
Setting 3: 90 sheets/minute
Setting 4: 105 sheets/minute
Setting 5: 120 sheets/minute

- When the main switch is turned on, Setting 3 is selected.
- The faster the printing speed becomes, the lighter the printing density is, and vice versa.

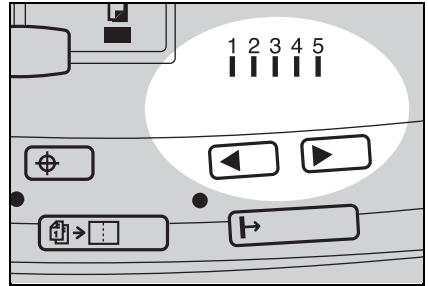

Stopping The Machine During A Print Run

When you want to stop the machine during a print run and print the next original

1 Press the **Stop** key.

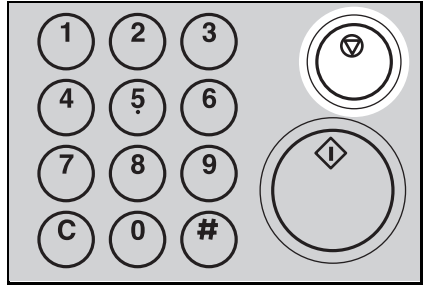

2 Press the **Master Making/Print** key to select Master Making mode.

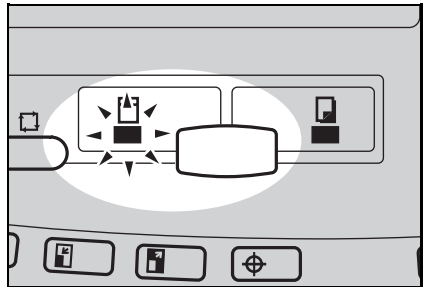

3 Set the new original.

4 Press the **Start** key.

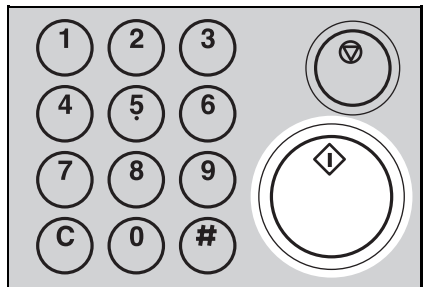

When you want to change the number of prints entered or check the completed prints

1 Press the **Stop** key.

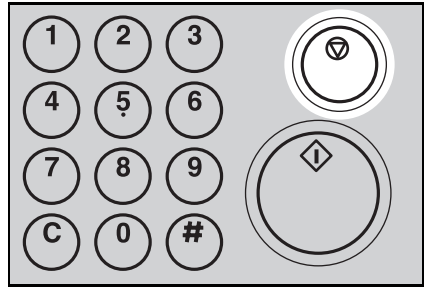

2 Change the number of prints or check the completed prints.

- When you change the number of prints, you can re-enter the number using the **Number** keys after pressing the **Stop** key.

3 Make sure that **Print** indicator is lit and then press the **Start** key.

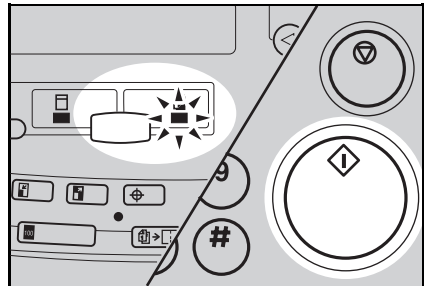

Reduction/Enlargement Printing (Reduce/Enlarge)

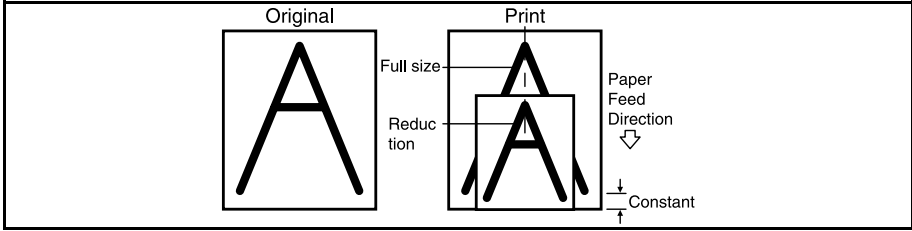

- The center and the leading edge of the print image do not shift when a print image is made with this function.

Reduction

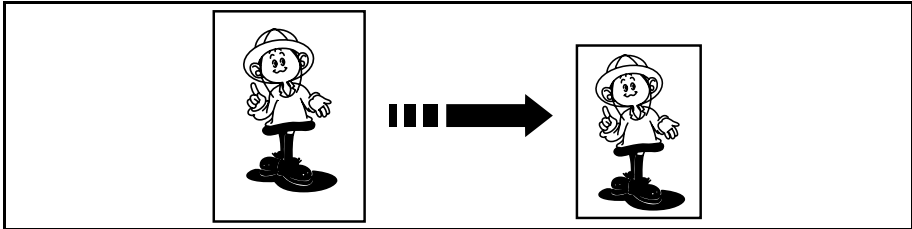

Prints can be reduced in size by using the **Reduce** key.

— *Metric version* —

— *Inch version* —

Reduction Ratio	Original Size	Print Size
93 %	*	
87 %	A5	B6
	A4	B5
82 %	B4	A4
	B5	A5
71 %	A4	A5
	B4	B5

Reduction Ratio	Original Size	Print Size
93 %	*	
77 %	8 1/2" x 14"	8 1/2" x 11"
74 %	10" x 14"	8 1/2" x 11"
65 %	8 1/2" x 11"	5 1/2" x 8 1/2"

* Select this ratio when you make prints with a lot of edge margins.

1 Select the desired reduction ratio using the **Reduce** key.

- If you want to return the ratio to 100 %, press the **Full Size** key.

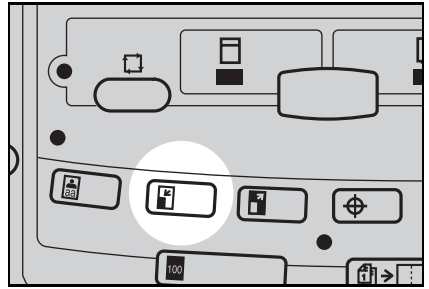

2 Make sure that the original and the print paper are the correct size.

3 Set your originals on the exposure glass or in the optional document feeder.

4 Make sure that **Master Making** indicator is lit and then press the **Start** key. Check the image position of the trial or proof print.

- If the image position is not correct, adjust it using the **Image Position** keys (↔ see page 21) or the side plate fine adjusting dial (↔ see page 22).

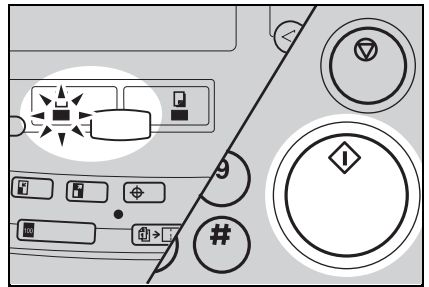

5 Enter the number of prints required using the **Number** keys.

6 Make sure that the **Print** indicator is lit and then press the **Start** key.

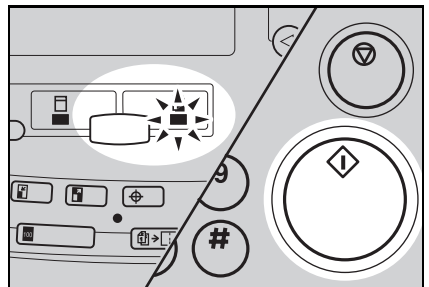

Enlargement

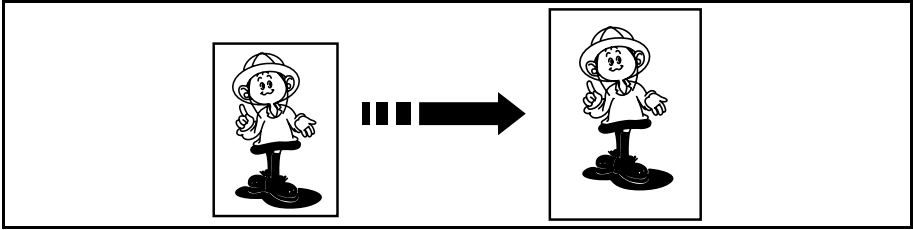

Prints can be enlarged by using the **Enlarge** key.

— *Metric version* —

Enlargement Ratio	Original Size	Print Size
141 %	B5	B4
	A5	A4
122 %	A4	B4
	A5	B5
115 %	B5	A4
	B6	A5

— *Inch version* —

Enlargement Ratio	Original Size	Print Size
155 %	5 1/2" x 8 1/2"	8 1/2" x 14"
129 %	5 1/2" x 8 1/2"	8 1/2" x 11"
121 %	8 1/2" x 11"	11" x 15"

1 Select the desired enlargement ratio using the **Enlarge** key.

- If you want to return the ratio to 100 %, press the **Full Size** key.

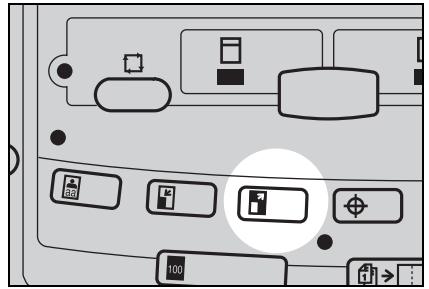

2 Make sure that the original and the print paper are the correct size.

3 Set your originals on the exposure glass or in the optional document feeder.

4 Make sure that **Master Making** indicator is lit and then press the **Start** key. Check the image position of the trial or proof print.

- If the image position is not correct, adjust it using the **Image Position** keys (↔ see page 21) or the side plate fine adjusting dial (↻ see page 22).

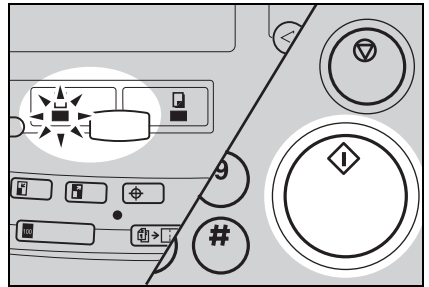

5 Enter the number of prints required using the **Number** keys.

6 Make sure that **Print** indicator is lit and then press the **Start** key.

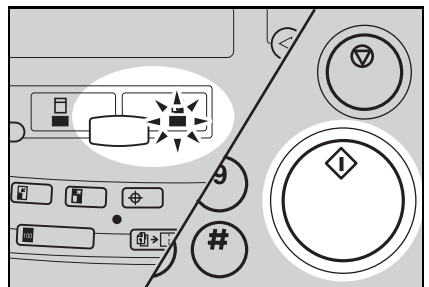

Erasing Center And Edge Margins (Edge Erase/Center Erase)

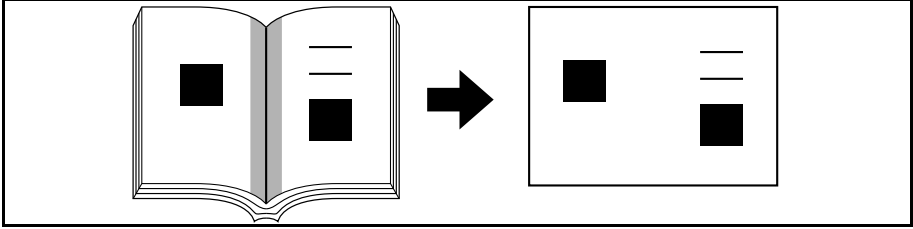

When printing from thick books, or similar originals, the binding margin at the center and the edges might appear on prints. To prevent this, follow the steps on the next page.

- As a default setting, the paper sizes and directions that can be used are as follows:
 - Metric version: B4 □, A4 □, A5 □, A5□, B5 □, B5 □
 - Inch version: 8 1/2" x 14" □, 8 1/2" x 11" □, 5 1/2" x 8 1/2" □, 5 1/2" x 8 1/2" □If you want to use other size originals, you can register the size using Service Program mode. ⚙ See page 107.
- The margin width to be erased can be adjusted with Service Program mode.
⚙ See page 107.

1 Press the **Edge Erase/Center Erase** key.

- To cancel this mode, press the **Edge Erase/Center Erase** key again.

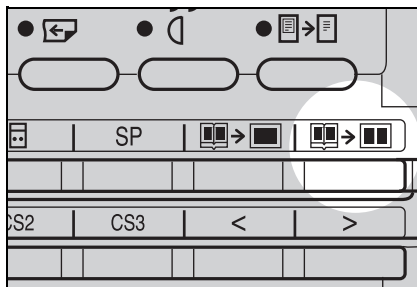

2 Press the "<" or ">" key to select the paper size and direction.

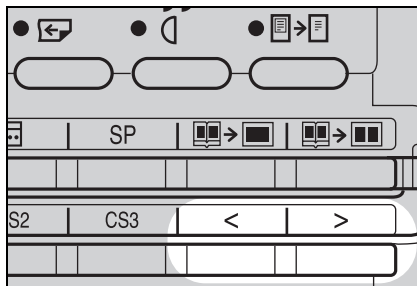

3 When you reach the desired paper size and direction, press the **Enter** key.

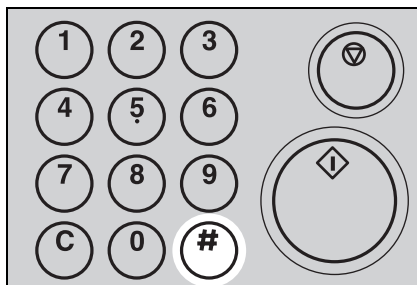

4 Set the book on the exposure glass.

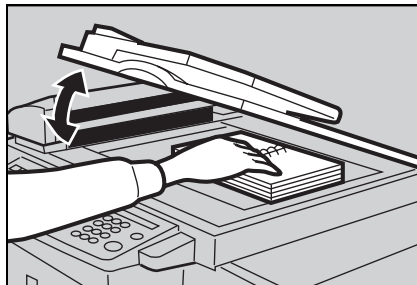

- 5** Make sure that **Master Making** indicator is lit and then press the **Start** key.

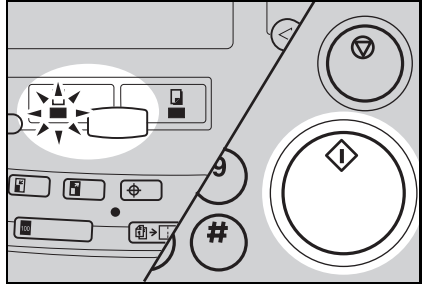

- 6** Check the image position of the trial or proof print.

- If the image position is not correct, adjust it using the **Image Position** keys (↔ see page 21) or the side plate fine adjusting dial (↺ see page 22).

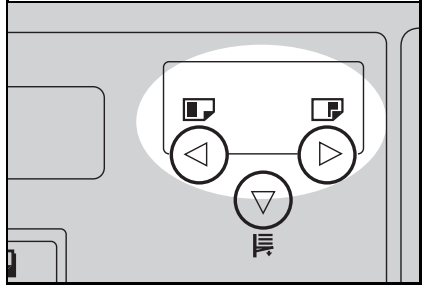

- 7** Enter the number of prints using the **Number** keys.

- 8** Make sure that **Print** indicator is lit and then press the **Start** key.

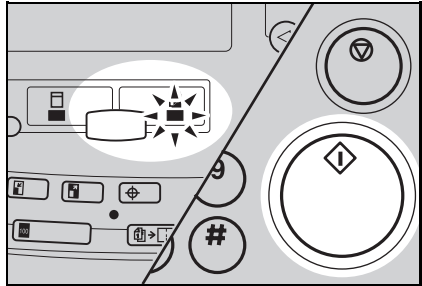

Erasing Edge Margins (Edge Erase)

If you want to erase edge margins of a book original, follow the steps below.

- ❑ As a default setting, the paper sizes and directions that can be used are as follows:
 - Metric version: B4 ☐, A4 ☐, A5 ☐, A5☐, B5 ☐, B5 ☐
 - Inch version: 8 1/2" x 14" ☐, 8 1/2" x 11" ☐, 5 1/2" x 8 1/2" ☐, 5 1/2" x 8 1/2" ☐
 If you want to use other size originals, you can register the size using Service Program mode. ☞ See page 107.
- ❑ The margin width to be erased can be adjusted with Service Program mode. ☞ See page 107.

1 Press the **Edge Erase** key.

- ❑ To cancel this mode, press the Edge Erase key again.

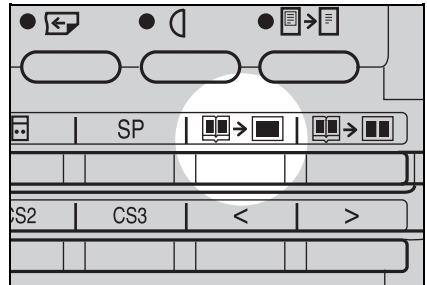

2 Press the "<" or ">" key to select the paper size and direction.

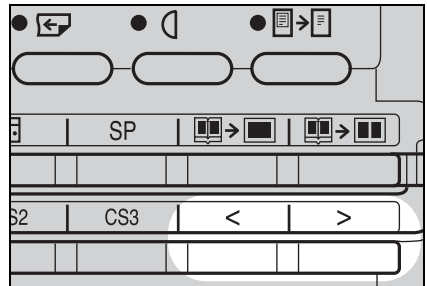

3 When you reach the desired paper size and direction, press the **Enter** key.

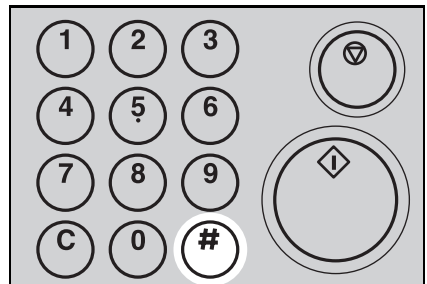

- 4** Set the book on the exposure glass.

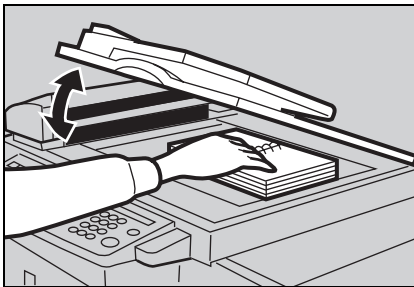

- 5** Make sure that **Master Making** indicator is lit and then press the **Start** key.

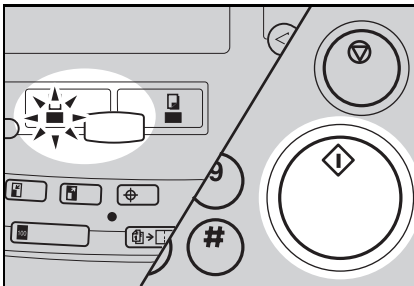

- 6** Check the image position of the trial or proof print.

- If the image position is not correct, adjust it using the **Image Position** keys (← see page 21) or the side plate fine adjusting dial (← see page 22).

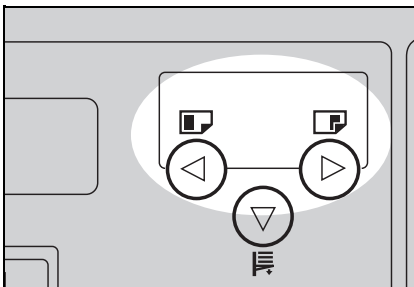

- 7** Enter the number of prints using the **Number** keys.

- 8** Make sure that **Print** indicator is lit and then press the **Start** key.

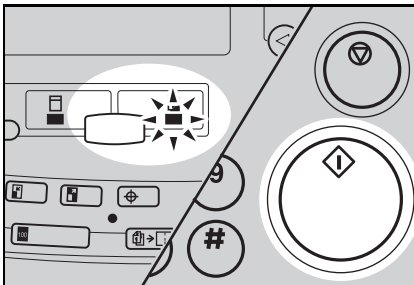

Erasing The Shadow Of Pasted Originals (Paste Shadow Erase)

If you want to erase the shadow of pasted originals, follow the steps below.

- 1** Set the original on the exposure glass.

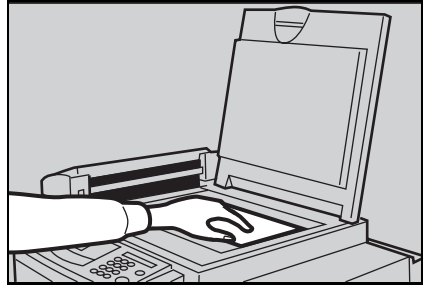

- 2** Press the **Paste Shadow Erase** key.

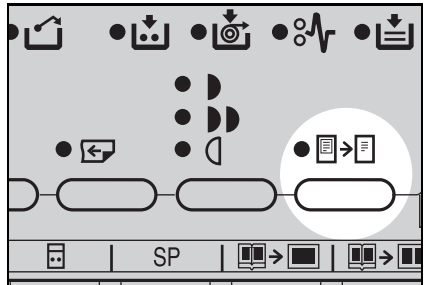

- 3** Make sure that **Master Making** indicator is lit and then press the **Start** key.

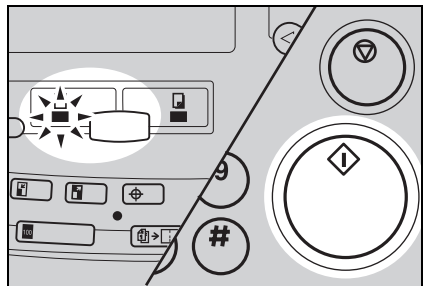

4 Enter the number of prints using the **Number** keys.

5 Make sure that **Print** indicator is lit and then press the **Start** key.

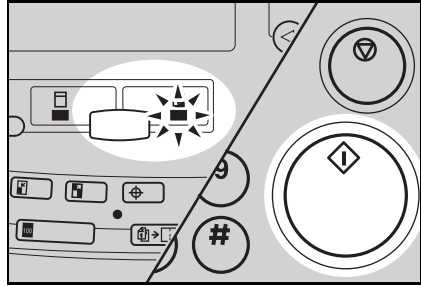

Printing On Thick Or Thin Paper

Printing on thick paper

If your paper applied to "Thick" in the table below, perform the following steps.

Weight \ Size	B4	A4	B5
209.3 g/m ² , 55.6 lb	Thick		Standard
157.0 g/m ² , 41.7 lb	Thick	Standard	
127.9 g/m ² , 34.0 lb	Thick	Standard	
47.1 g/m ² ~ 105 g/m ² , 12.5 lb ~ 28 lb	Standard		

- 1** Push down the feed roller pressure lever.

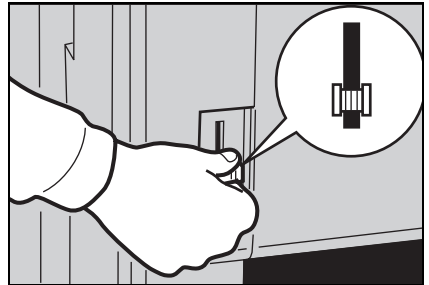

- 2** Push the separation roller pressure levers up to the thick paper position.

- There are two pressure levers. Make sure that both levers are up.

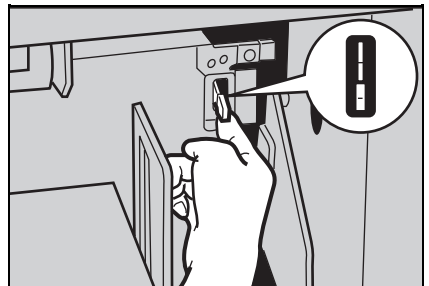

Printing on thin paper

- 1** Set the side pads (move the side pad levers to the right).

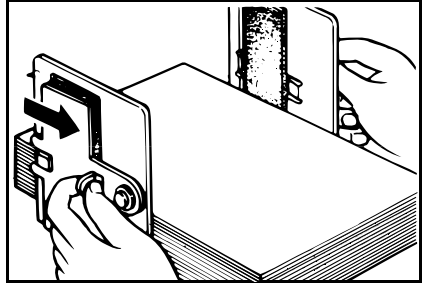

- 2** Position the feed roller pressure lever to the Standard paper position.

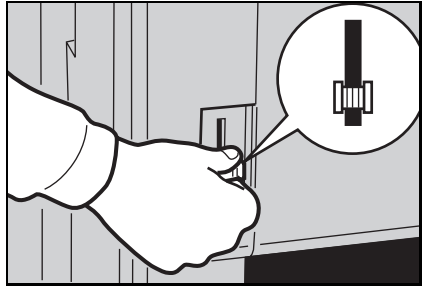

- 3** Set the separation roller pressure levers to the standard position.

- There are two pressure levers. Make sure that both levers are down.

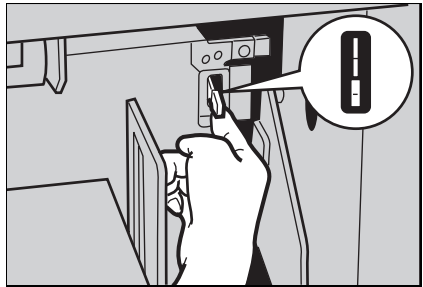
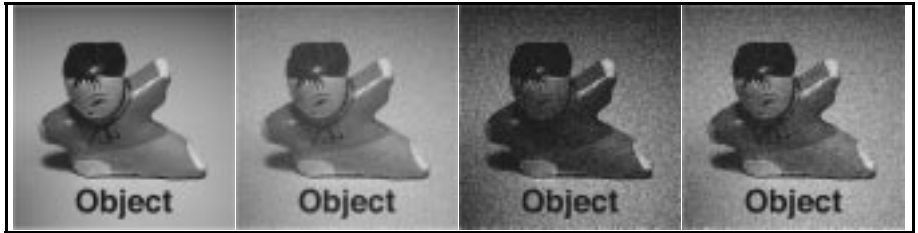

Photo Mode Printing (Type of Original)



Original

Photo mode

Letter mode

Letter/Photo mode

When printing a photograph or a color original, select Photo mode.

- Moire patterns may occur when screened originals are printed.
- When printing originals with both letters and photos using Photo mode, the image of the letters will be light. Select Letter/Photo mode using the **Type of Original** key.

- 1** Press the **Type of Original** key to select Photo mode.

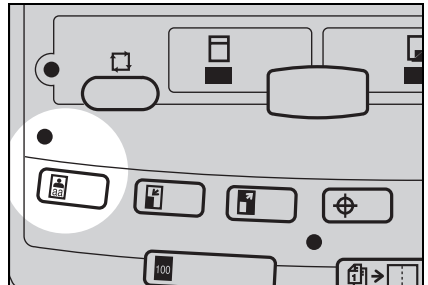

- 2** Press the **Image Density** key to adjust the image density.

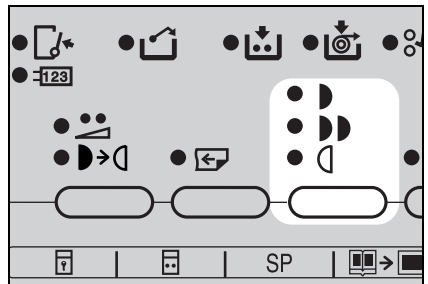

3 Set your originals on the exposure glass or in the optional document feeder.

4 Make sure that the **Master Making** indicator is lit and then press the **Start** key. Check the image position of the trial or proof print.

- If the image position is not correct, adjust it using the **Image Position** keys (← see page 21) or the side plate fine adjusting dial (← see page 22).

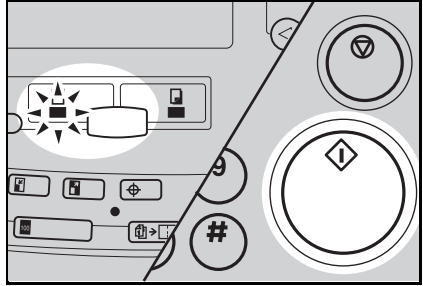

5 Enter the number of prints using the **Number** keys.

6 Make sure that the **Print** indicator is lit and then press the **Start** key.

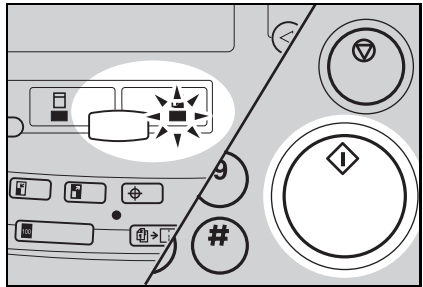

Ink Saving (Economy Mode)

When you want to save ink, select Economy mode.

- The printing density may be light in this mode.

- 1** Press the **Economy/Tint** key to select Economy mode.

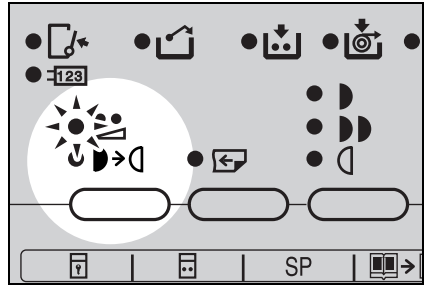

- 2** Set your originals on the exposure glass or in the optional document feeder.

- 3** Make sure that the **Master Making** indicator is lit and then press the **Start** key. Check the image position of the trial or proof print.

- If the image position is not correct, adjust it using the **Image Position** keys (↔ see page 21) or the side plate fine adjusting dial (↻ see page 22).

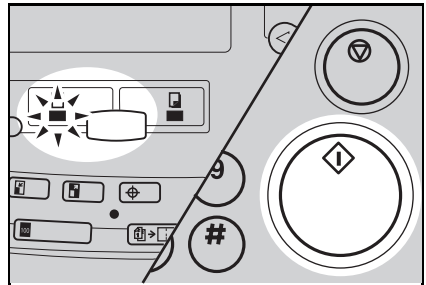

- 4** Enter the number of prints using the **Number** keys.

- 5** Make sure that the **Print** indicator is lit and then press the **Start** key.

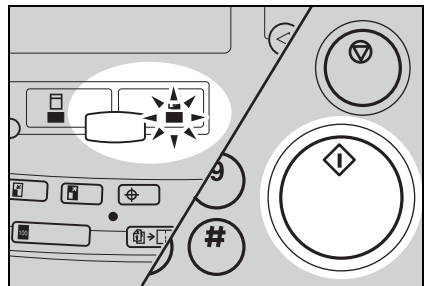

Making Half-tone Prints (Tint Mode)

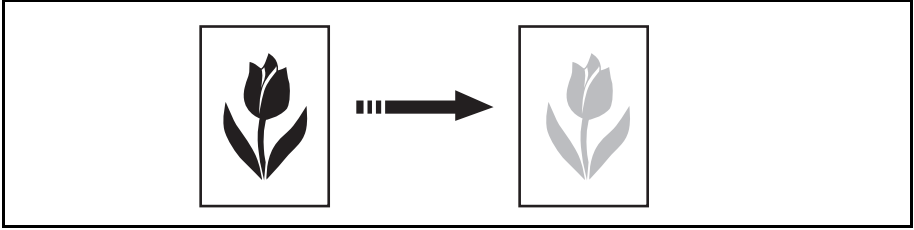

- 1 Press the **Economy/Tint** key to select Tint mode.

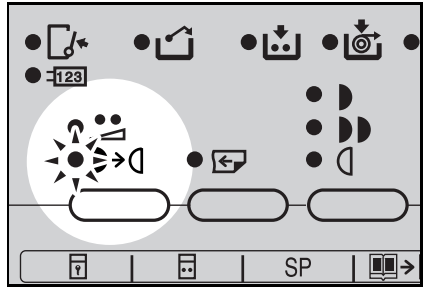

- 2 Set your originals on the exposure glass or in the optional document feeder.

- 3 Make sure that the **Master Making** indicator is lit and then press the **Start** key. Check the image position of the trial or proof print.

- If the image position is not correct, adjust it using the **Image Position** keys (↔ see page 21) or the side plate fine adjusting dial (↔ see page 22).

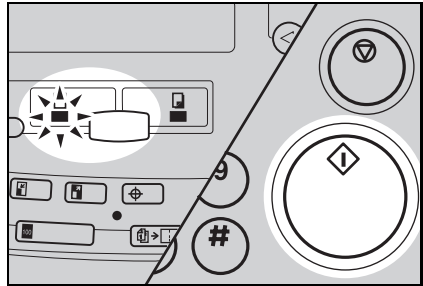

- 4 Enter the number of prints using the **Number** keys.

- 5** Make sure that the **Print** indicator is lit and then press the **Start** key.

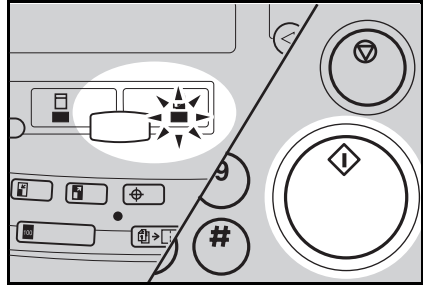

Printing From Several Originals At Once (Auto Cycle)

Use the **Auto Cycle** key to process masters and make prints at one stroke.

- ❑ When you use the optional document feeder, it is not necessary to place originals one by one. All originals are fed and prints are completed after you press the **Start** key.
- ❑ If you use the optional tape dispenser, the tape dispenser drops a strip of paper onto the top of the paper stack after the last page of each printing set is fed out to the paper delivery table. This marks the end of each printing group.

1 Set the original on the exposure glass or in the optional document feeder.

- ❑ You can set up to 30 originals into the optional document feeder.

2 Press the **Auto Cycle** key.

- ❑ Both indicators of Master Making mode and Print mode are lit.
- ❑ If you press the **Auto Cycle** key, you cannot make proof prints by pressing the **Proof** key.

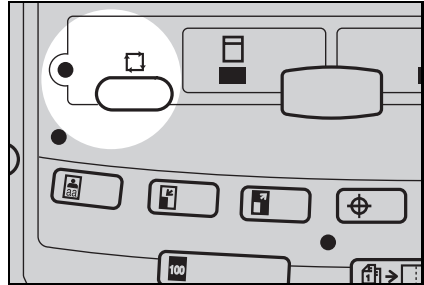

3 Enter the number of prints using the **Number** keys.

4 If you use the optional tape dispenser, turn on the power switch of the tape dispenser.

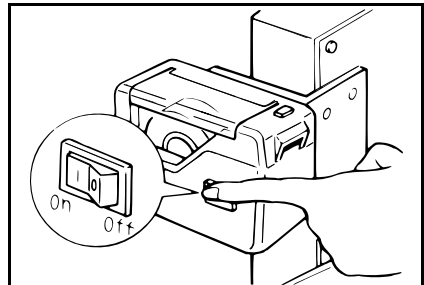

5 Press the **Start** key.

- If you set the originals into the optional document feeder, originals are fed and prints are completed automatically.

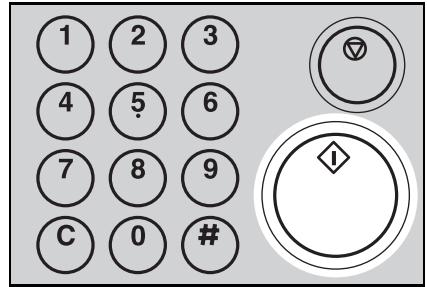

6 Repeat steps 1 through 5 until all originals are printed when you set originals on the exposure glass.

- After the last page of each set is fed out to the paper delivery table, the optional tape dispenser drops a strip of paper on the top of the paper stack. The next cycle begins.

Printing With A Programmed Number Of Prints For Each Class (One Touch Class Mode)

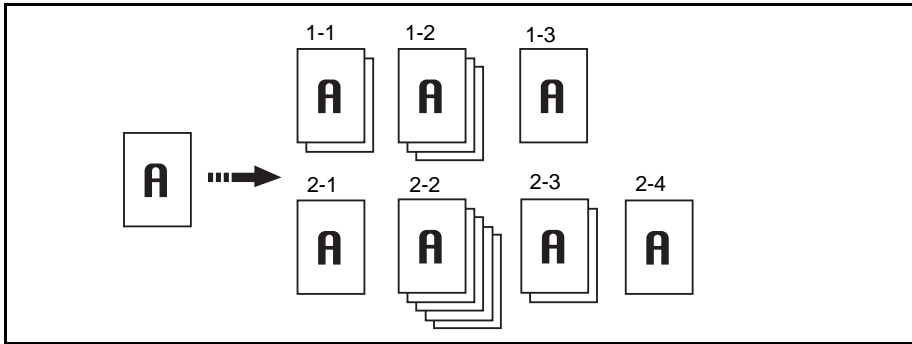

What is One Touch Class mode?

This feature is useful for teachers who frequently make multiple print sets for their classes, e.g. notes, handouts, tests etc.

Using a standard print function, the teacher would have to stand by the machine entering the number of prints and pressing the Start key for each class. However, One Touch Class mode allows you to program the number of students in each class into the machine beforehand. Then, whenever you need to make print sets for several classes, set your original, select the classes who need prints and press the Start key. Print sets will be made containing the correct number of prints for each class.

- If you have the Tape Dispenser option, print sets will be sent to the paper delivery table separated by a slip of tape for easy separation. If you do not have this option, the machine will stop after each set has been printed. In this case, remove the stack from the paper delivery table and press the Start key to start printing the next set.
- You can program student numbers for up to 9 grades with 10 classes in each, giving a maximum of 90 classes. Each class can have up to 9999 students.

Example:

Imagine a school with 4 grades and 6 classes in each grade. There are 27 students in every class in grades 1 to 3, and grade 4 has varying numbers of students due to a high transfer rate. The information you need to program in the machine might look like that shown in the table below:

Grade \ Class	1	2	3	4	5	6
1	27	27	27	27	27	27
2	27	27	27	27	27	27
3	27	27	27	27	27	27
4	25	20	23	24	25	20

Programming student numbers

Before you can use One Touch Class Mode, you need to program the number of students in each class. Because classes are grouped into grades, you must program one grade at a time.

There are two methods of programming a grade:

Simple: Use if all classes in a grade have the same number of students. (saves entering the same number over and over again)

Multi: Use if class student numbers vary.

- Note that to specify a grade, you need to use the One Touch Class keys. If you cannot see the key you need, flip over the plate (see below).

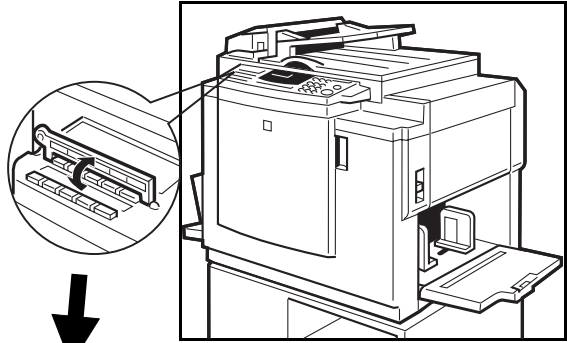

One Touch Class keys

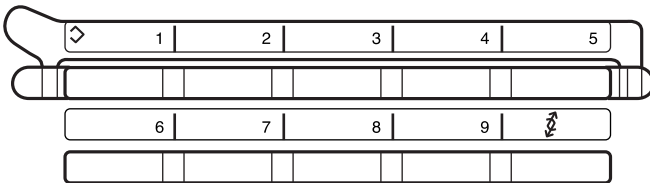

Simple programming

In this example we will program student numbers for grade 1 of the table shown on page 48.

The information on the guidance display is in the format:

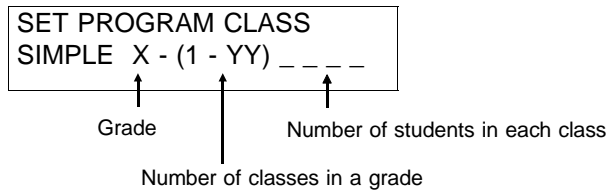

- If you want to clear any class numbers you have programmed, you need to program each class number as "0".

1 Press the **Program Class** key.

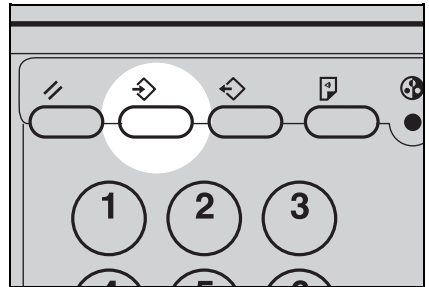

2 Enter the grade you wish to program with the **One Touch Class** keys.

- E.g. to Program grade 1, press the One Touch Class key 1.

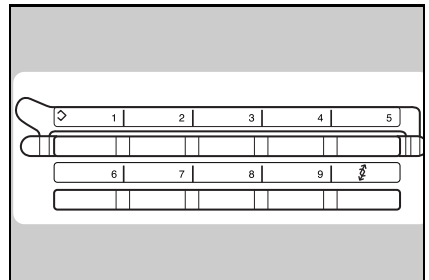

- The guidance display will appear as opposite.

SET PROGRAM CLASS SIMPLE 1-(1-YY) _ _ _ _
--

3 Enter the number of students per class using the **Number** keys then press the **Enter** key.

- E.g. press "2", "7" and "#" key.



SET PROGRAM CLASS
SIMPLE 1 - (1 - YY) _ _ 2 7

- The guidance display will appear as opposite.
- If you want to clear the class you have programmed, enter "0" then press the **Enter** key.

4 Enter the number of classes in the 1st grade with the **Number** keys then press the **Enter** key.

- E.g. press "6" and "#" key.

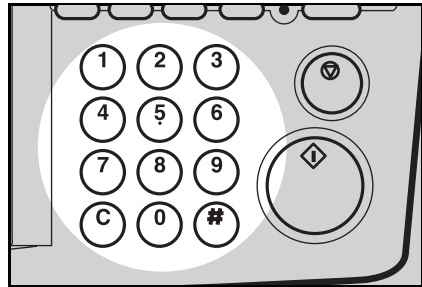

5 You now have two options:

- Program another grade: go to step 2.
- Finish programming: press the **Clear Modes** key.

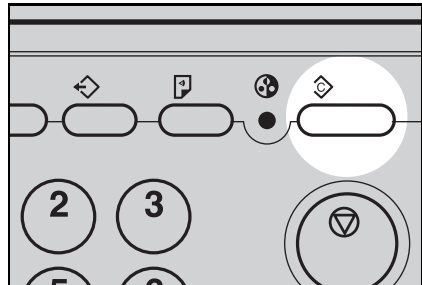

Multi-programming

In this example we will program student numbers for grade 4 of the table shown on page 48.

The information on the guidance display is in the format:

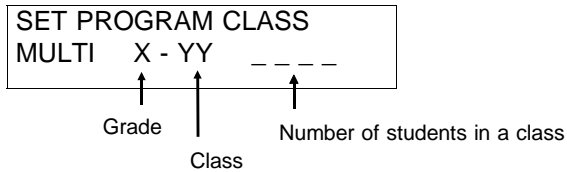

- If you want to clear any class numbers you have programmed, you need to program each class number as "0".

1 Press the **Program Class** key.

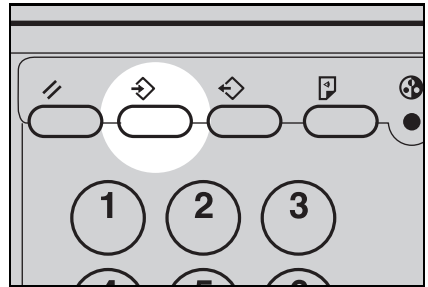

2 Press the **Mode** key to select multi programming mode.

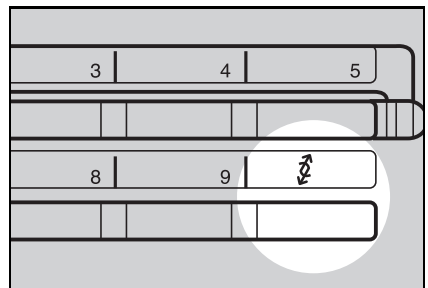

- The guidance display will appear as opposite.

SET PROGRAM CLASS		
MULTI	X - 1	----

3 Enter the grade you wish to program.

- E.g. to program grade 4, press the **One Touch Class** key 4.

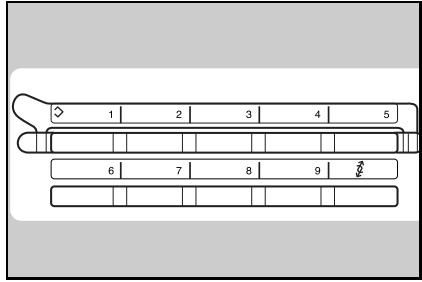

SET PROGRAM CLASS
MULTI 4 - 1 _ _ _ _

- The guidance display will appear as opposite.

4 Enter the number of students in class 1 with the **Number** keys, then press the **Enter** key.

- E.g. press "2", "5" and "#" key.

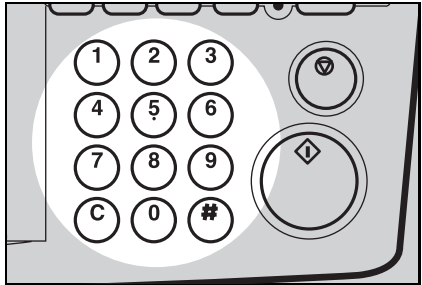

SET PROGRAM CLASS
MULTI 4 - 2 _ _ _ _

- The guidance display will show it is ready for you to enter the next class.

- If you want to clear the class you have programmed, enter "0" then press the **Enter** key.

5 You now have three options:

- Program the remaining classes in this grade: repeat steps 4 for all classes.
- Program another grade: go back to step 3.
- Finish programming: press the **Clear Modes** key.

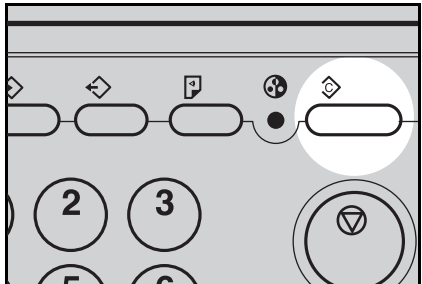

Protecting One Touch Class settings

If you want to prevent someone from writing over your settings, you can protect each grade.

- 1** While pressing the **Reset** and **Stop** key simultaneously, press the **Program Class** key.

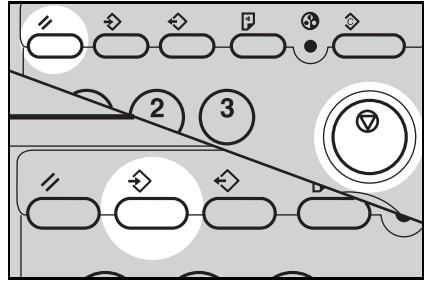

- The guidance display will appear as opposite.

0 : CANCEL PROTECTION	
1 : PROTECT	NO. _

- 2** Enter "1" using the **Number** keys.

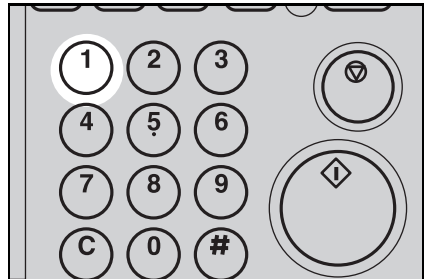

- 3** Press the **Enter** key.

- The grade which are not protected will be displayed in the guidance display.

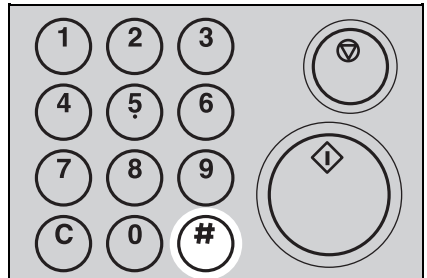

- 4** Using the **Number** keys, enter the grade that you want to protect.

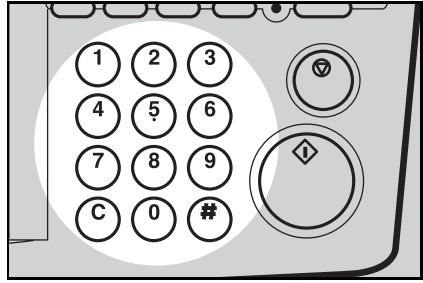

- 5** Press the **Enter** key.

Cancelling protection

- 1** While pressing the **Reset** and **Stop** key simultaneously, press the **Program Class** key.

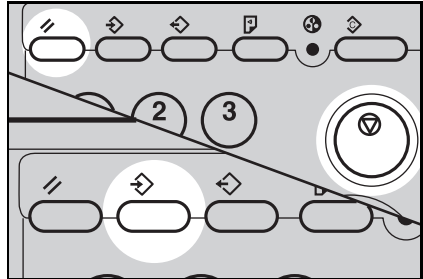

- The guidance display will appear as opposite.

0 : CANCEL PROTECTION	
1 : PROTECT	NO. _

- 2** Enter "0" using the **Number** keys.

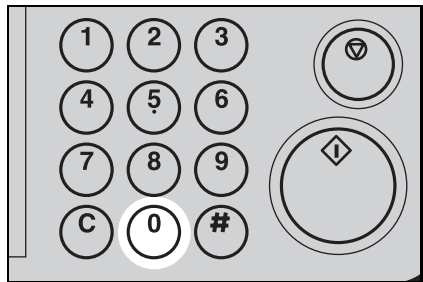

3 Press the **Enter** key.

- The grades which are protected will be displayed in the guidance display.
- If no grade is protected, the machine returns to the ready condition.

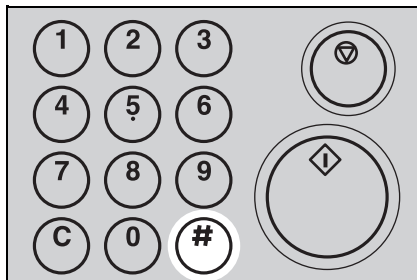

4 Using the **Number** keys, enter the grade that you want to cancel protection.

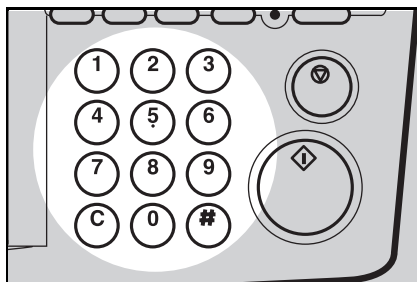

5 Press the **Enter** key.

Making prints with One Touch Class mode

Example 1 -- making prints for all classes in a grade

The example describes how to make print sets for all classes in the 1st and 2nd grades.

1 Set the original on the exposure glass or in the optional document feeder.

2 Make sure that the **Master Making** indicator is lit and then press the **Start** key. Check the image position of the trial or proof print.

- If the image position is not correct, adjust it using the **Image Position** keys (☞ See page 21) or the side plate fine adjusting dial (☞ See page 22).

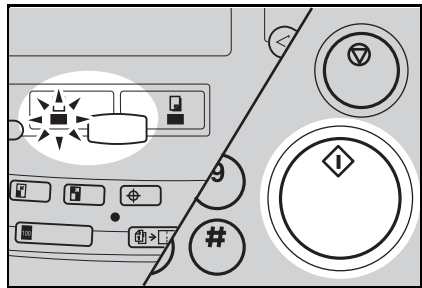

3 Enter the first grade you wish to make prints for.

- E.g. to select grade 1, press the **One Touch Class** key 1.

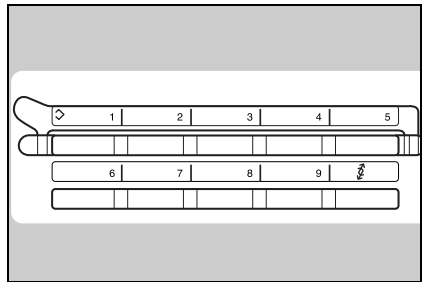

4 Press the **Enter** key.

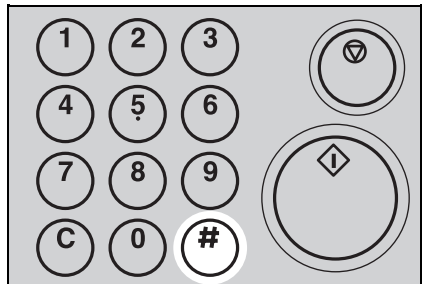

5 Enter the next grade you want to make prints for.

- E.g. to select grade 2, press the **One Touch Class** key 2.

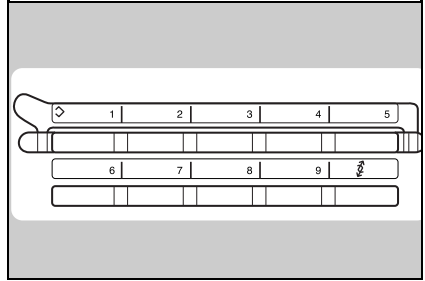

6 Press the **Enter** key.

- To select more grades, just repeat steps 5 and 6.

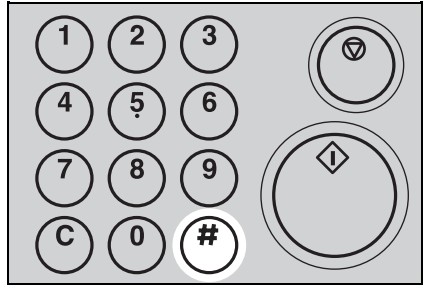

7 If you have the optional tape dispenser, switch it on.

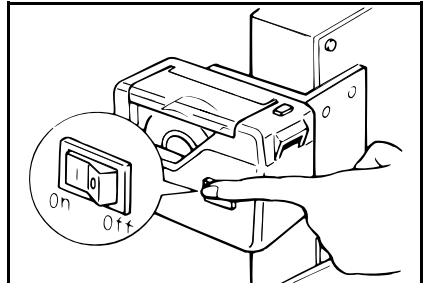

8 Make sure that the **Print** indicator is lit and then press the **Start** key.

- After the last page of each printing set is fed out to the paper delivery table, the tape dispenser drops a strip of paper on the top of the paper stack.
- If the power switch of the optional tape dispenser is turned off or the tape dispenser is not installed in your machine, the machine stops after each set is delivered. Remove the set of prints from the paper delivery table and press the **Print Start** key to start printing the next set.

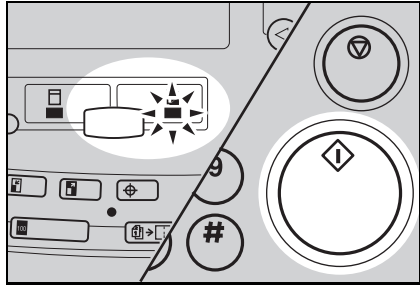

Example 2 -- making prints for selected classes

This procedure describes how to make prints for selected classes in different grades.

1 Set the original on the exposure glass or in the optional document feeder.

2 Make sure the **Master Making** indicator is lit and then press the **Start** key. Check the image position of the trial or proof print.

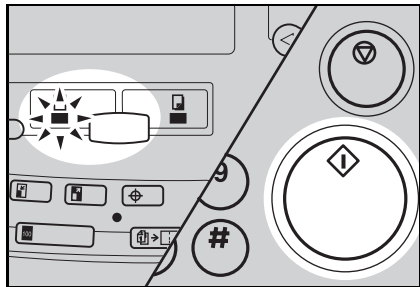

3 Enter a grade number with the **One Touch Class** keys.

- E.g. press the One Touch Class key 1.

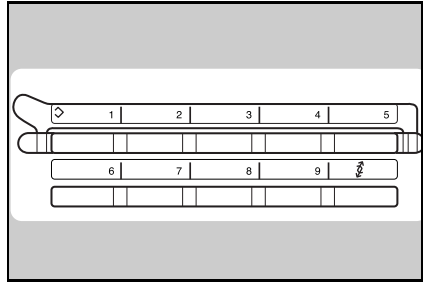

4 Enter a class number with the **Number** keys.

- E.g. press "2" key.

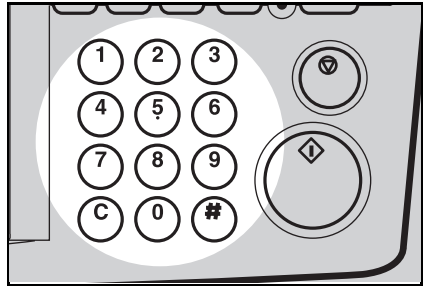

5 Press the **Enter** key.

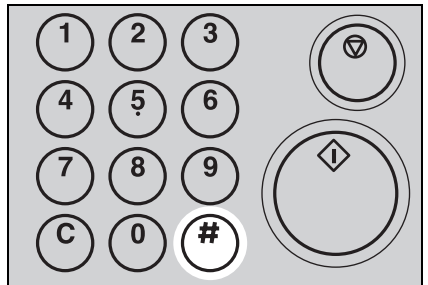

6 You have three options:

- Select another class in this grade: go to step 3
- Select another class from a different grade: go to step 3
- Finish selecting classes: go to step 7

- 7** If you have the optional tape dispenser, switch it on.

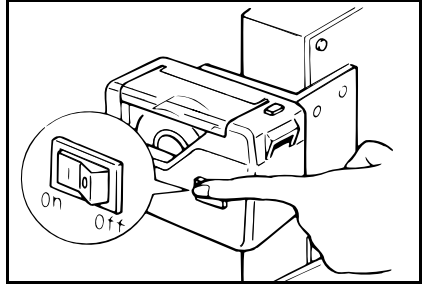

- 8** Make sure that the **Print** indicator is lit and then press the **Start** key.

- If you do not have the optional tape dispenser, you will need to remove the copies from the paper delivery tray after each print set is finished, then press the **Start** key to continue printing.

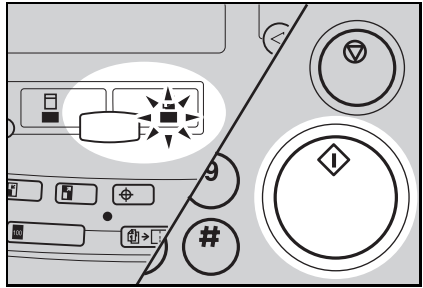

Checking how many prints will be made in One Touch Class mode

If you want to find out the programmed class numbers before making prints, do the following steps after step 6 (page 58) or step 5 (page 60):

- 1** Flip over the plate so you can see the "<" and ">" keys.

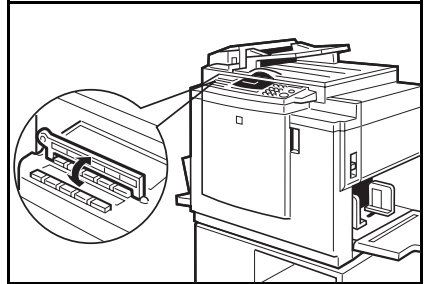

- 2** Hold down the **Reset** and **Stop** keys simultaneously and use the "<" and ">" keys to scroll through the classes.

- The machine will beep when you reach the end or beginning of the list.
- If Print Program Class is set to "Last" (see page 103), pressing the "<" key shows classes from the last class set.

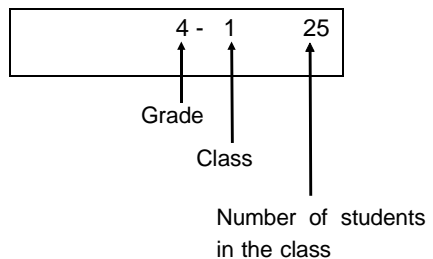
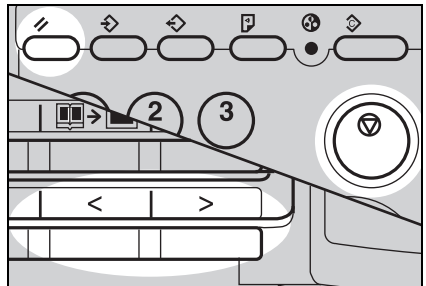

Combine 2 Originals

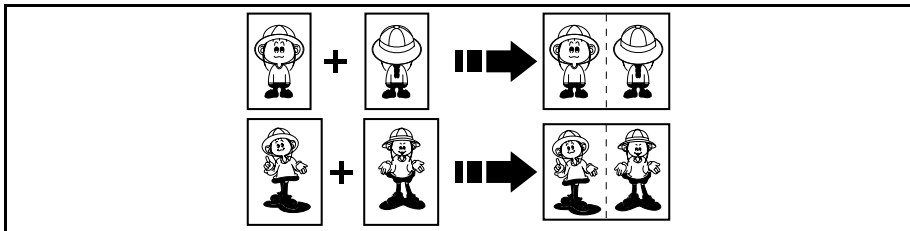

You can print 2 separate originals on a single sheet of paper. The following tables list the combinations that can be used when combining two originals.

— *Metric version* —

Original Size Paper Size	B5 □	A5 □	B6 □	A6 □
B4 □	100 %	122 %	141 %	—
A4 □	82 %	100 %	115 %	141 %
B5 □	71 %	87 %	100 %	122 %
A5 □	—	71 %	82 %	100 %

— *Inch version* —

Original Size Paper Size	5 1/2" x 8 1/2" □
8 1/2" x 14" □	100%
8 1/2" x 11" □	100%
5 1/2" x 8 1/2" □	65%

- When you set an original on the exposure glass, the machine cannot detect the original length. So you have to enter the original size with Edge Erase function.
- When you use the optional document feeder with this function, see page 85.







- If the master length of the first original is longer than the maximum allowable length or shorter than the minimum allowable length, Combine 2 Originals mode is canceled. The following table gives the maximum and minimum allowable master length.

Master length = actual original length x Enlargement/Reduction ratio

	Minimum	Maximum
B4 drum model	91 mm, 3.6"	243 mm, 9.5"
A4 drum model	91 mm, 3.6"	198 mm, 7.7"

- Any image closer than 5 mm, 0.2" to the leading edge of the first original will not be printed. Also, any image closer than 4 mm, 0.16" to the leading edge of the second original will not be printed. When the image is too close to the leading edge, use copies of the originals with the image shifted at least 5 mm, 0.2" for the first original (4 mm, 0.16" for the second original) from the leading edge.
- You can select different kinds of image settings for the first and second original.
- Make sure that the paper feed side plates contact the paper lightly in the Combine 2 Originals function. Otherwise, the two original images do not appear at the proper position on the prints.

Example 1: When using 100 % reproduction ratios

	1st original size	2nd original size	Paper size
Metric version	B5 	B5 	B4 
Inch version	5 1/2" x 8 1/2" 	5 1/2" x 8 1/2" 	8 1/2" x 11" 

1 Set the first original face down.

- The first original will be printed on the leading part of the print.

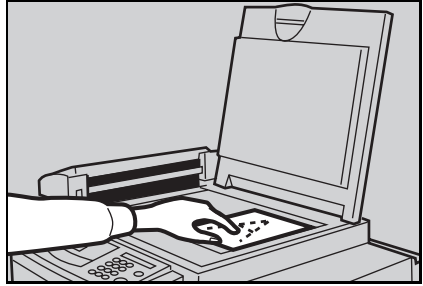

2 Press the **Combine 2 Originals** key.

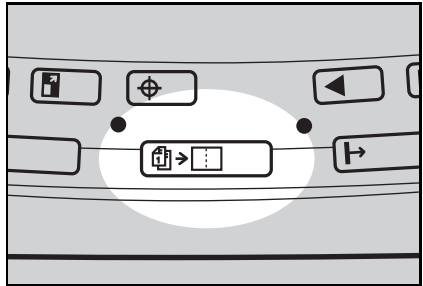

3 Press the **Edge Erase** key.

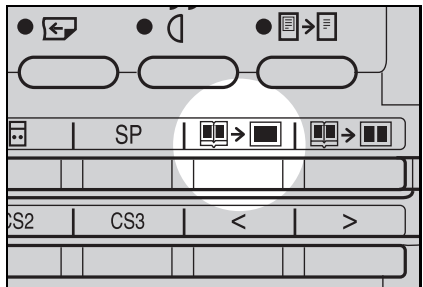

- 4** Press the "<" or ">" key to select the original size and direction.

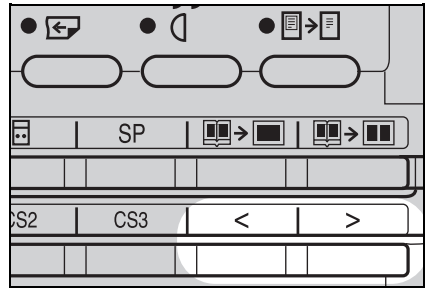

- 5** When you reach the desired size and direction (metric version: B5 □, inch version: 5 1/2" x 8 1/2" □), press the **Enter** key.

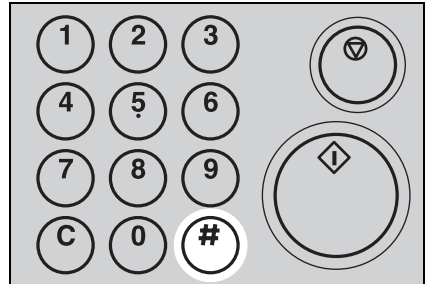

- 6** Make sure that the **Master Making** indicator is lit and then press the **Start** key.

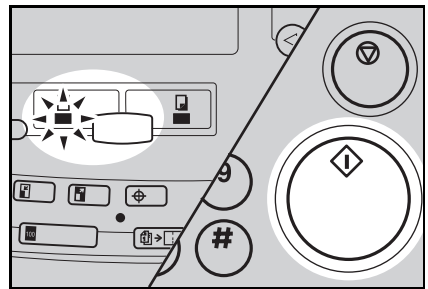

- 7** The beeper sounds after the first original is on the master. Set the second original face down.

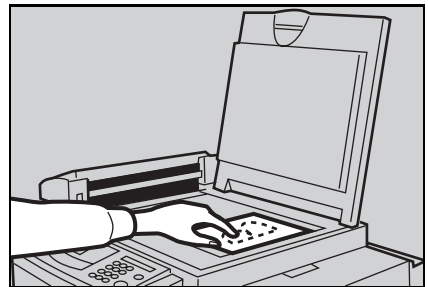

8 Make sure that the **Master Making** indicator is lit and then press the **Start** key. Check the image position of the trial or proof print.

- If the image position is not correct, adjust it using the **Image Position** keys (☞ See page 21) or the side plate fine adjusting dial. (☞ See page 22.)

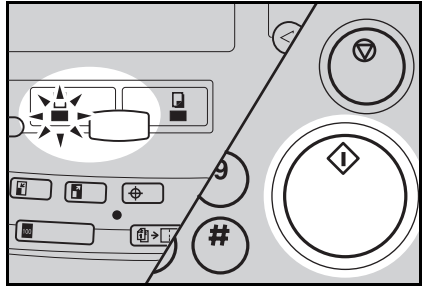

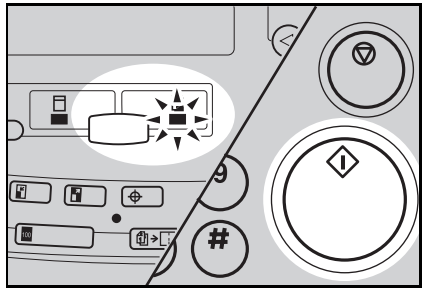

9 Enter the number of prints required using the **Number** keys.

10 Make sure that the **Print** indicator is lit and then press the **Start** key.



Example 2: When using enlarging or reducing ratios

	1st original size	2nd original size	Paper size
Metric version	B6 	B5 	B4 

1 Set the first original face down.

- The first original will be printed on the leading part of the print.

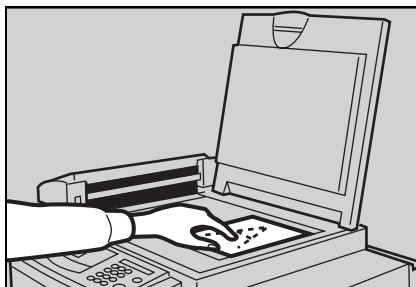

2 Press the **Combine 2 Originals** key.

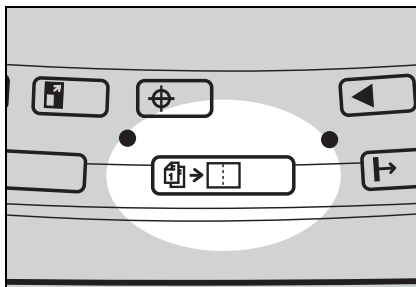

3 Press the **Edge Erase** key.

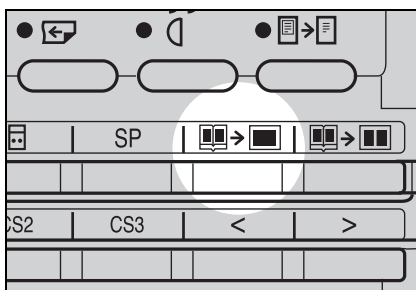

- 4** Press the "<" or ">" key to select the original size and direction.

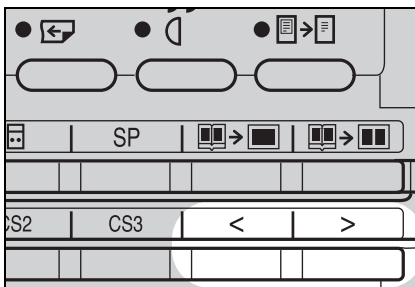

- 5** When you reach the desired size and direction (metric version: B6 □), press the **Enter** key.

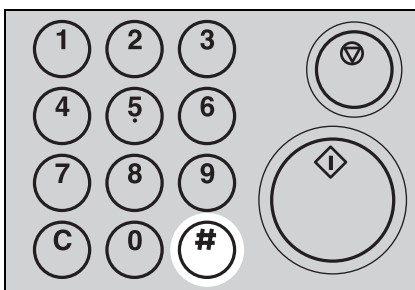

- 6** Press the **Reduce** or **Enlarge** key to select the suitable reproduction ratio to match the paper size (metric version: 141 %).

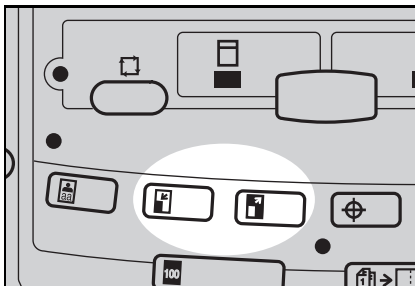

- 7** Make sure that the **Master Making** indicator is lit and then press the **Start** key.

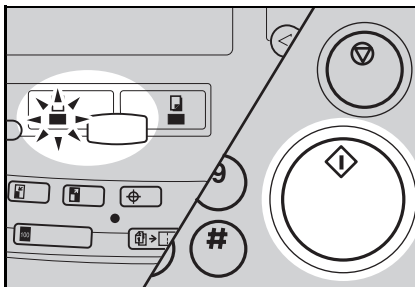

8 The beeper sounds after the first original is on the master. Set the second original face down.

9 Make sure that the **Master Making** indicator is lit and then press the **Start** key. Check the image position of the trial or proof print.

- If the image position is not correct, adjust it using the **Image Position** keys (← See page 21) or the side plate fine adjusting dial. (← See page 22.)

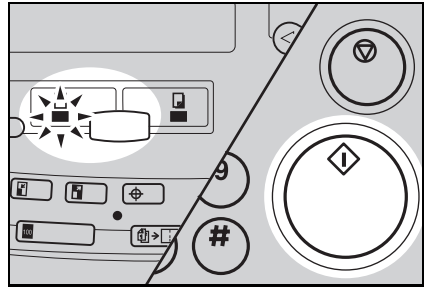

10 Enter the number of prints required using the **Number** keys.

11 Make sure that the **Print** indicator is lit and then press the **Start** key.

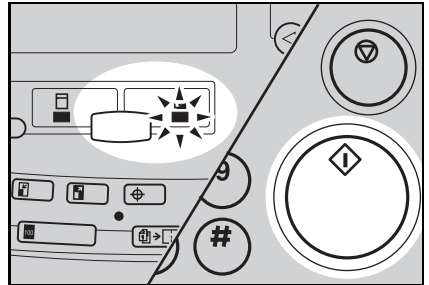

Skip Feed Printing (Skip Feed Mode)

If the back of prints are dirty, you can increase the time between two prints using the **Skip Feed** key. In the default setting, when one sheet of paper is fed the drum rotates once. However, you can select the number of rotations of the drum. This gives you the chance to remove prints one by one from the paper delivery table or insert one sheet of paper between two prints. If you use this function, you can also use paper longer than 447 mm, 17.5" in spite of the maximum length limitations of paper.

- ❑ The maximum length of paper in Skip Feed mode is 590 mm, 23.2".
- ❑ When you use paper longer than 447 mm, 17.5", completed prints will not be delivered to the paper delivery table properly, so receive them by hand.

1 Set your originals on the exposure glass or in the optional document feeder.

2 Make sure that the **Master Making** indicator is lit and then press the **Start** key. Check the image position of the trial or proof print.

- ❑ If the image position is not correct, adjust it using the **Image Position** keys (← See page 21) or the side plate fine adjusting dial. (← See page 22.)

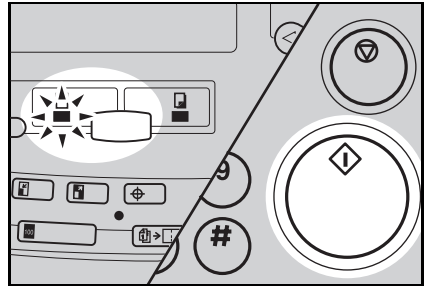

3 While pressing the **Skip Feed** key, select the number of rotations of the drum while one sheet of paper is fed, using the **Number** key.

- ❑ You can select from 1 to 9 rotations.
- ❑ The beeper sounds after you set the number of rotations.

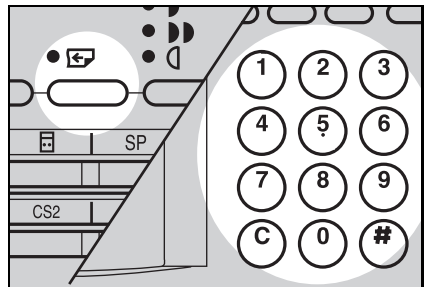

- 4 Enter the number of prints using the **Number** keys.
- 5 Make sure that the **Print** indicator is lit and then press the **Start** key.

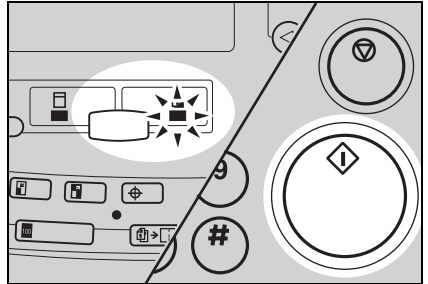

User Program

This User Program function allows you to store and recall up to 9 frequently used job setups.

- ❑ The stored programs are not cleared when you turn off the main switch.

How to input a user program

1 Select and enter the job settings you want to store in memory.

2 Press the **Program** key.

- ❑ The program menu is displayed on the guidance display.

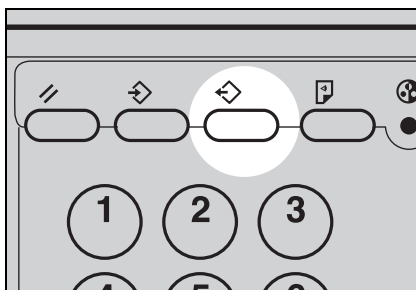

3 Enter "0" using the **Number** key.

4 Press the **Enter** key.

- ❑ The program numbers (1 to 9) will be displayed in the guidance display.
- ❑ If a user program has been protected, that program number will not appear in the display. For changing a protected user program, see page 78.
- ❑ If all the user programs have been protected, the machine returns to the ready condition.

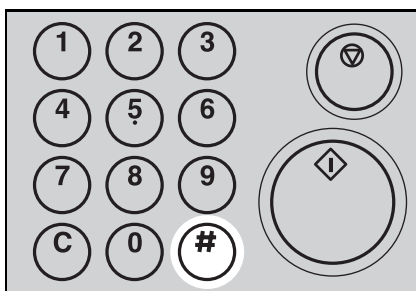

5 Enter one of the program numbers displayed on the guidance display using the **Number** keys.

- ☐ Make sure that the previous job settings stored under the selected program number are overwritten.

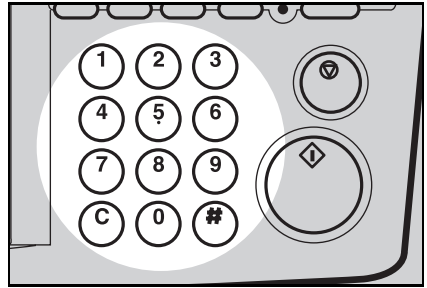

6 Press the **Enter** key.

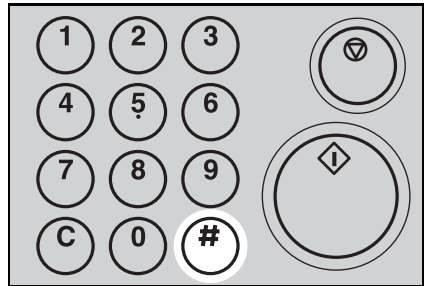

How to access a user program

1 Press the **Program** key.

- ☐ Numbers already containing a program are displayed on the guidance display.

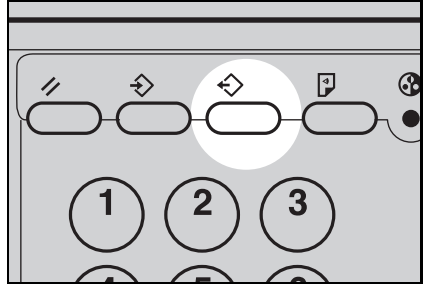

2 Using the **Number** keys, enter the number of the program that you want to access.

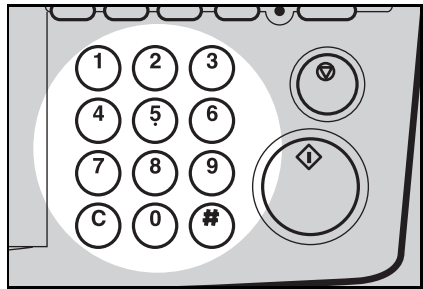

3 Press the **Enter** key.

- ☐ All stored job settings are recalled.

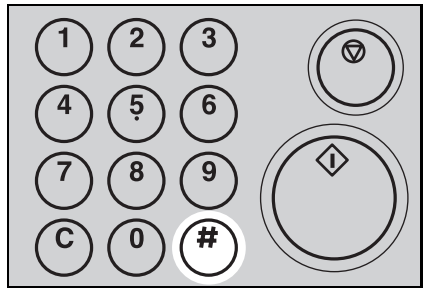

4 Set your originals on the exposure glass or in the optional document feeder.

5 Make sure that the **Master Making** indicator is lit and then press the **Start** key.

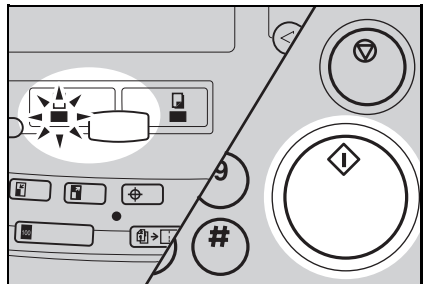

How to protect a program

If you want to prevent someone from writing over your program, do the following procedure.

- 1** While pressing the **Reset** key and **Stop** key simultaneously, press the **Program** key.

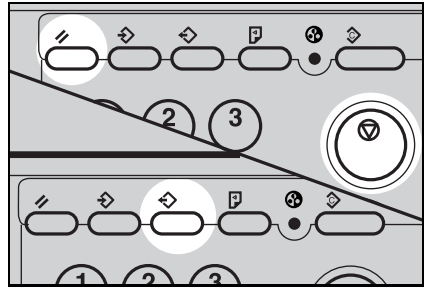

- 2** Enter "1" using the **Number** key.

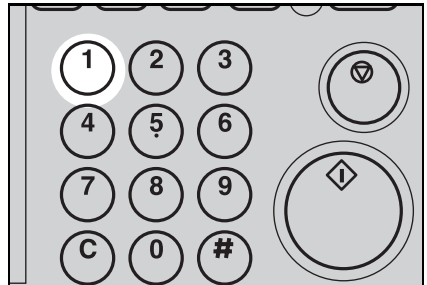

- 3** Press the **Enter** key.

- The numbers of the programs which are not protected will be displayed in the guidance display.
- If all the user programs have been protected or no program is stored, the machine returns to the ready condition.

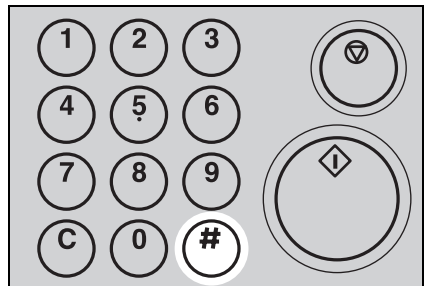

4 Using the **Number** keys, enter the number of the program that you wish to protect.

5 Press the **Enter** key.

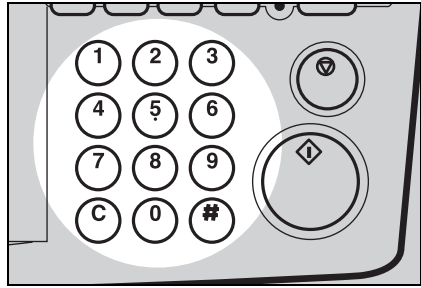

How to remove user program protection

- 1** While pressing the **Reset** key and **Stop** key simultaneously, press the **Program** key.

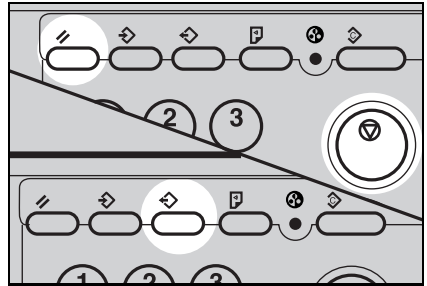

- 2** Enter "0" using the **Number** key.

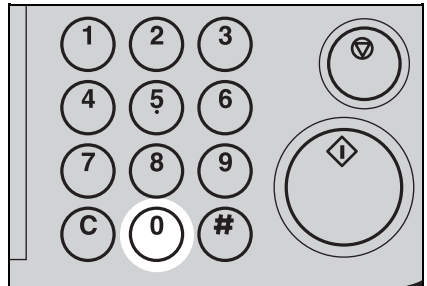

- 3** Press the **Enter** key.

- If not program number is protected or no program is stored, the machine returns to the ready condition.

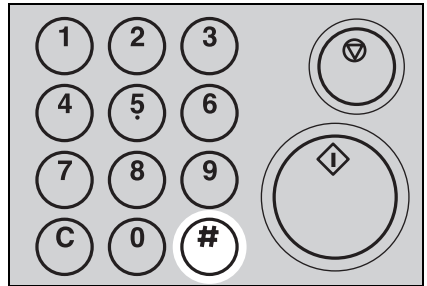

- 4** Using the **Number** keys, enter the number of the program that you wish to remove protection from.

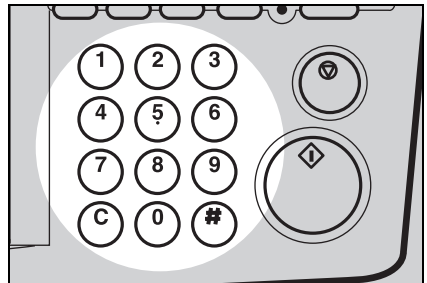

- 5** Press the **Enter** key.

Printing Of Secret Documents (Security Mode)

This function prevents others from making prints of secret documents using its master.

1 Make your prints.

2 Press the **Security** key.

- If you press the Start key in Print mode or press the **Proof** key after finishing one print job, the beeper sounds and you cannot make prints.
- You cannot cancel Security mode even if you turn off the main switch.
- If you make the next master, Security mode is canceled.

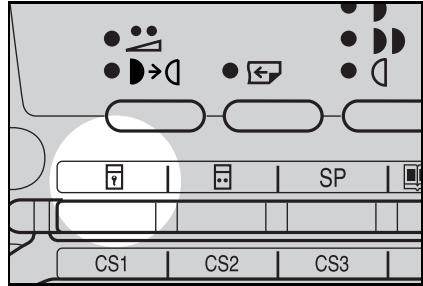

Recovering The Image Density (Quality Start)

If the machine is not used for a long period of time, the image density might decrease because the ink on the drum might dry. Printing quality can be regained by making a few prints. The Quality Start function recovers the image density quality by making a print with slow printing speed (20 sheets/minute). It prevents you from making extra prints.

- ❑ You can select how many times Quality Start mode is carried out for each master making using Service Program mode. ➔ See page 105.
- ❑ When you set the Quality Start function, the bold letters or solid images may be light.
- ❑ If you use the Quality Start function before 6 hours have passed after the last operation, the image density may not be recovered earlier. However, it is convenient to use this function when you change drum unit and make prints before 6 hours have passed after the last operation.

1 Set your originals on the exposure glass or in the optional document feeder.

2 Press the **Quality Start** key.

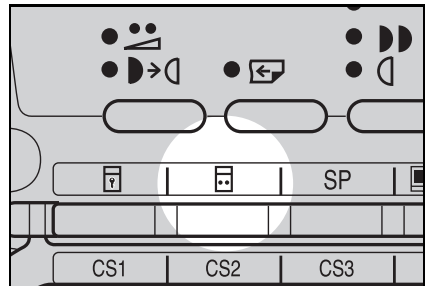

3 Make sure that **Master Making** indicator is lit and then press the **Start** key.

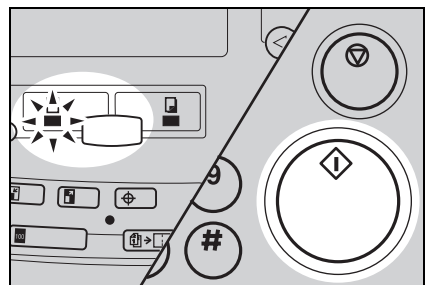

4 Enter the number of prints using the **Number** keys.

5 Make sure that the **Print** indicator is lit and then press the **Start** key.

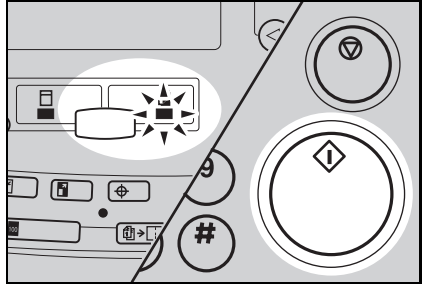

OPTIONAL FUNCTIONS

Printing Using The Optional Document Feeder

Guide to document feeder components

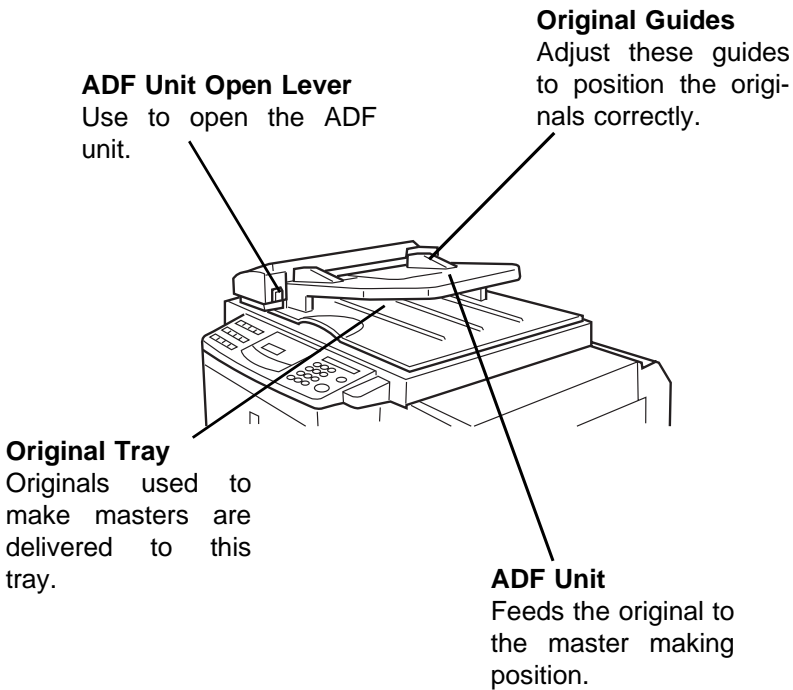

Originals

- ❑ The following types of originals are not recommended for use with the optional document feeder. Set these types of originals on the exposure glass.
 - Originals heavier than 90 g/m², 23.9 lb (when setting a stack of originals)
 - Originals lighter than 50 g/m², 13.3 lb (when setting a stack of originals)
 - Originals heavier than 120 g/m², 31.9 lb (when setting one original at a time)
 - Originals lighter than 40 g/m², 10.6 lb (when setting one original at a time)
 - Carbon coated originals
 - Damaged originals
 - Originals with glue on them
 - Originals perforated for ring binders
 - Book originals
 - Originals written with a pencil or ball-point pen
 - Originals smaller than 148 mm x 105 mm, 5.8" x 4.1"
 - Originals larger than 257 mm x 364 mm, 10.2" x 14.4"
 - Folded, curled, creased originals
 - Bound, stapled, or clipped originals
 - OHP transparencies
 - Translucent paper
 - Pasted originals
- ❑ If you use paste-up originals, make sure the pasted parts hold firmly to the base sheet and press the **Paste Shadow Erase** key. If the thickness of the paste-up original is more than 0.1 mm, and the space between the pasted parts is less than 2 mm, 2/25", a shadow might appear on the prints.
- ❑ The first 5 mm, 0.2", of the leading edge cannot be printed. Make sure the leading edge margin is at least 5 mm, 0.2".

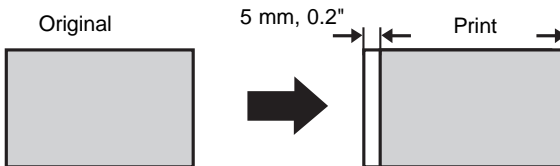

Setting originals into the document feeder

- ❑ If you set one original into the document feeder while another original is still on the exposure glass, the original set into the document feeder will be scanned first.

1 Adjust the original guides to the size of the originals.

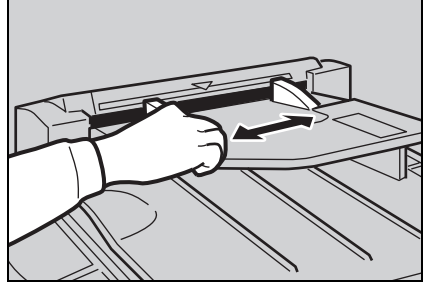

2 Insert the originals face up in the document feeder until it stops.

- ❑ Do not insert different size originals at the same time.
- ❑ Approximately 30 originals can be inserted at one time in the document feeder. The top original will be fed first.
- ❑ The guides must fit snugly against both sides of the stack.

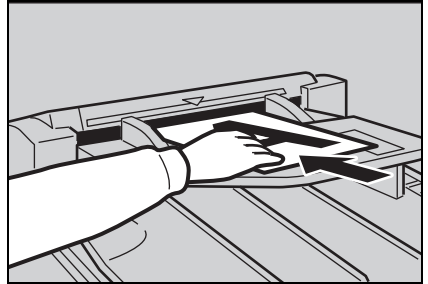

3 Set the required image settings.

4 Make sure that **Master Making** indicator is lit and then press the **Start** key.

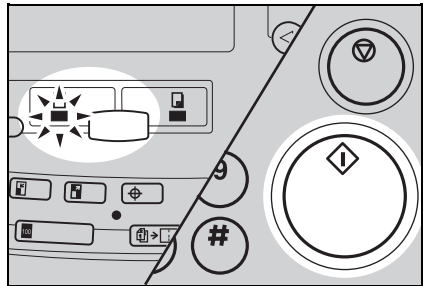

5 Make your prints.

Combine 2 originals with the document feeder

- For details about Combine 2 Originals function, ➔ See page 63.

1 Insert the 2 originals face up.

- The top original will be printed on the leading part of print.

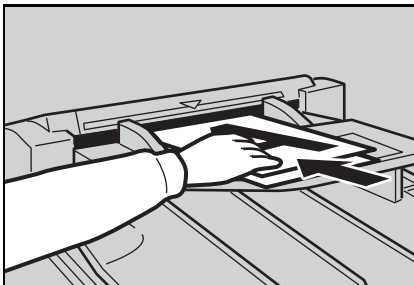

2 Press the **Combine 2 Originals** key.

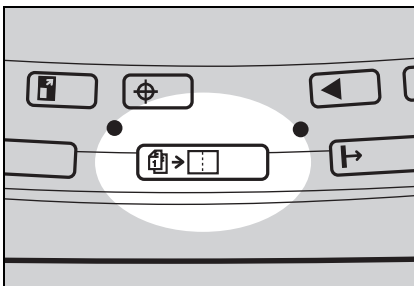

3 Check the print paper size and the reproduction ratio.

4 Enter the number of prints using the **Number** keys.

5 Make sure that the **Master Making** indicator is lit and then press the **Start** key.

- After the first original is on the master, the second original is fed.
- If you set only one original, the beeper sounds after the first original is on the master. Set the second original and the desired image settings. Then, press the **Start** key.

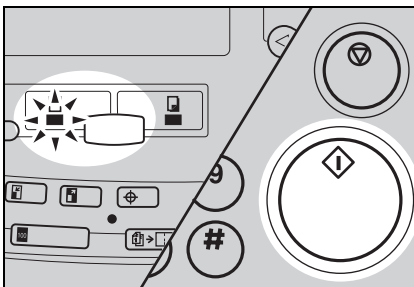

- 6** Make sure that **Print** indicator is lit and then press the **Start** key.

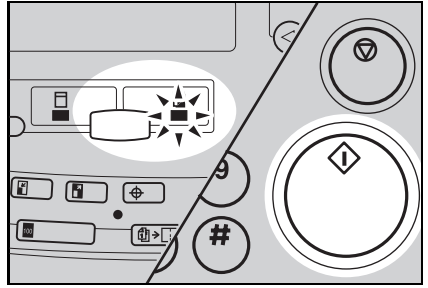

Printing with One Touch Class mode

- ❑ For details about One Touch Class mode, see page 47.
- ❑ To prevent original misfeed, do not set originals of different sizes.
- ❑ Do not set more than 30 originals at one time.

1 Set the originals face up into the document feeder.

- ❑ The originals are fed from the top of the stack. Make sure that the originals are set in the correct sequence with the first original on top.

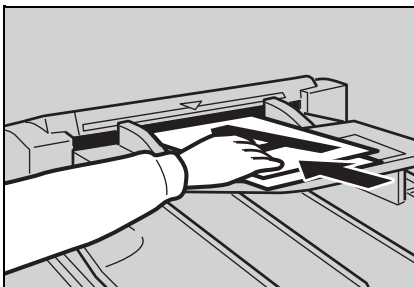

2 Follow the steps from 2 to 7 on pages 57 ~ 58 or pages 59 ~ 61.

3 Press the **Auto Cycle** key.

- ❑ In Auto Cycle mode, printing starts automatically after a trial print is delivered.

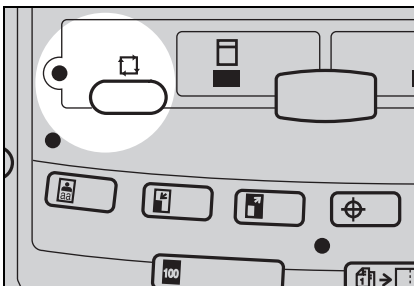

4 Make sure that the **Print** indicator is lit and then press the **Start** key.

- ❑ After the last page of each set is fed out to the paper delivery table, the tape dispenser drops a strip of paper on the top of the paper stack. The next cycle begins.

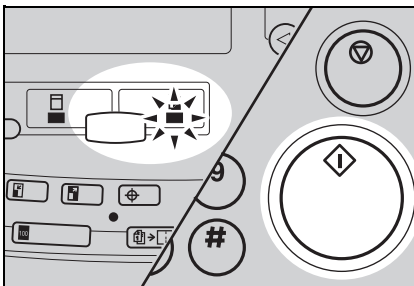

Color Printing Using The Optional Color Drum

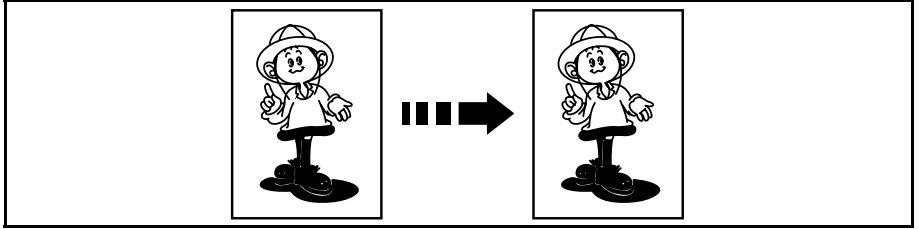

Color drum units (red, blue, green, brown, yellow, purple, navy, maroon, orange and teal) are available as options in addition to the standard black unit. For making color prints, a separate drum unit is necessary for each color.

Making color prints

- 1** Make sure that the **Color Drum** indicator is lit.

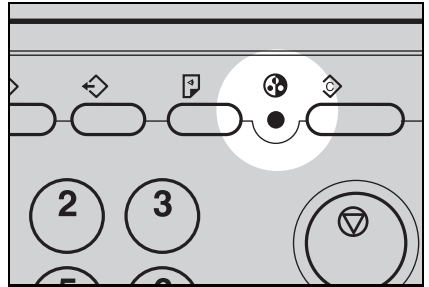

- 2** Make sure that **Master Making** indicator is lit and then press the **Start** key. Check the image position on the trial or proof print.

- If the image position is not correct, adjust it using the **Image Position** keys (↔ see page 21) or side plate fine adjusting dial (↔ see page 22).

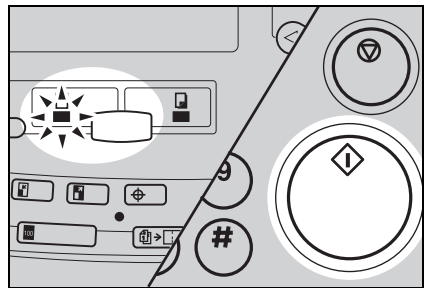

- 3** Make your prints.

Changing the drum unit for color printing

1 Open the front door.

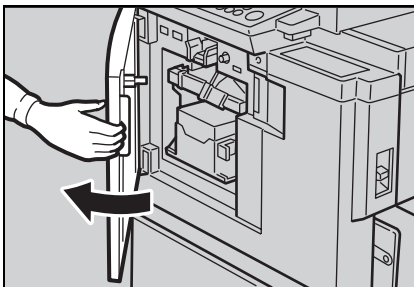

2 Press the drum rotation button until the beeper sounds.

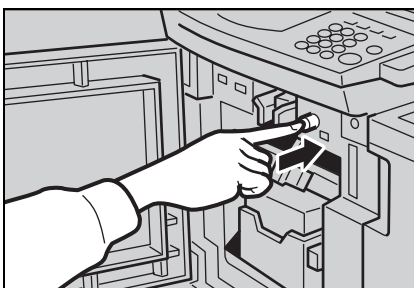

3 Lift the lock lever until it locks in position.

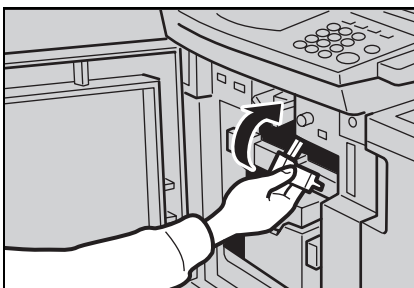

4 Pull out the drum unit handle while pressing the release bar inside the green handle.

- If you cannot pull out the drum unit even when the lamp of the drum rotation button is green, push the drum unit handle, then pull out the drum unit.

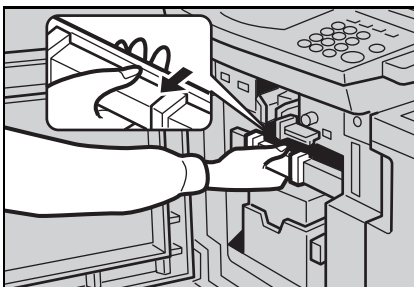

- 5** Hold the rail on the drum and slide out the drum while pulling the release towards you.

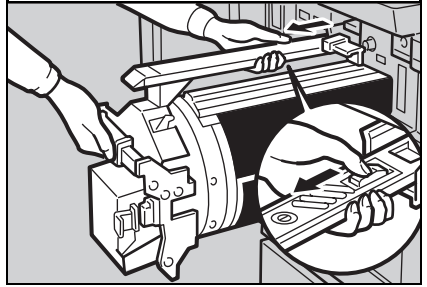

- 6** Remove the drum unit from the machine while holding the upper drum stay.

Note:

Be careful not to let the drum unit fall.

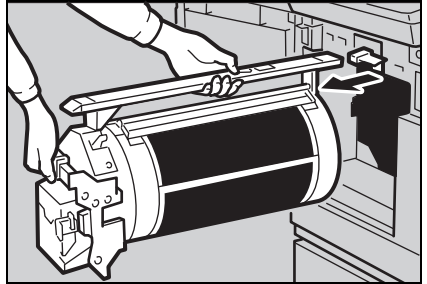

- 7** Insert the color drum unit along the guide rail.

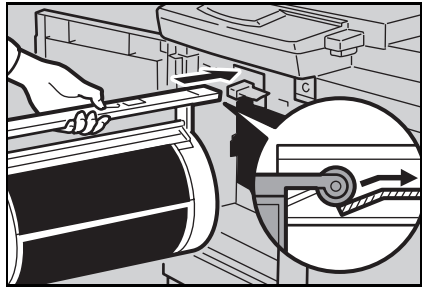

- 8** Slide in the drum unit until the drum unit locks in position.

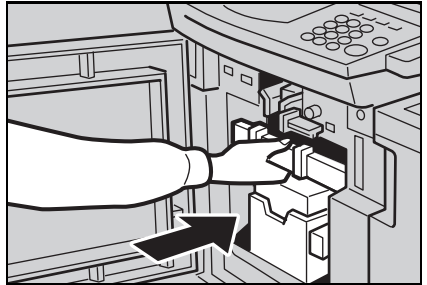

9 Lower the drum unit lock lever.

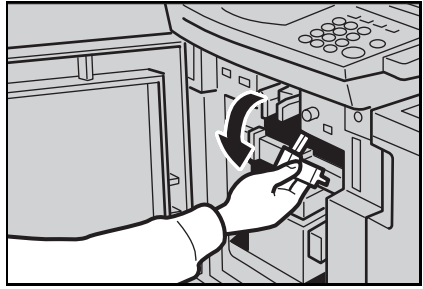

10 Close the front door.

- Make sure that the Cover Open indicator turns off, and the Color Drum indicator lights.

Printing in two colors

After printing in one color, you can print in another color on the same side of the print.

- You cannot print in two colors at one time.
- Leave the prints for a while before printing on them again to let the ink dry.

1 Prepare the two originals. Set the first original on the exposure glass.

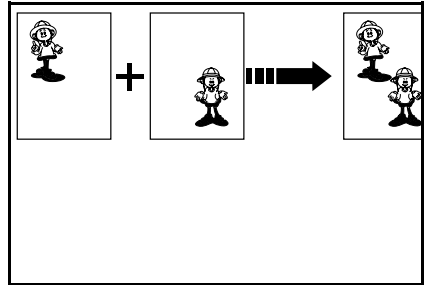

2 Make sure that **Master Making** indicator is lit and then press the **Start** key. Check the image position of the trial or proof print.

- If the image position is not correct, adjust it using the **Image Position** keys (↔ see page 21) or the side plate fine adjusting dial (↔ see page 22).

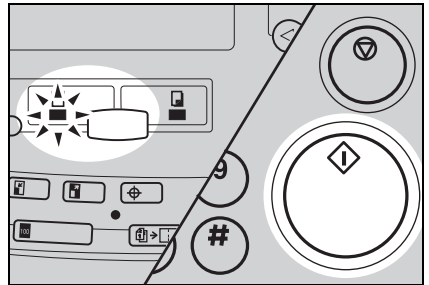

3 Enter the number of prints using the **Number** keys.

4 Make sure that **Print** indicator is lit and then press the **Start** key.

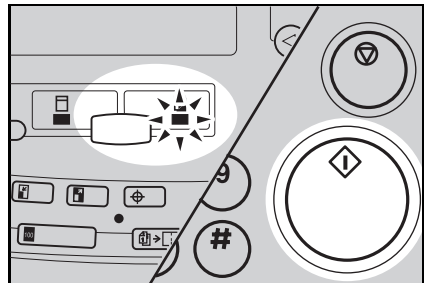

- 5** Remove the prints from the paper delivery table and set them on the paper feed table again as shown in the illustration.



- 6** Exchange the drum unit. ➔ See pages 89 ~ 91.

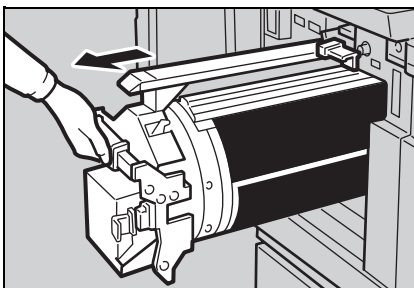

- 7** Set the second original. Make sure that **Master Making** indicator is lit and then press the **Start** key. Check the image position.

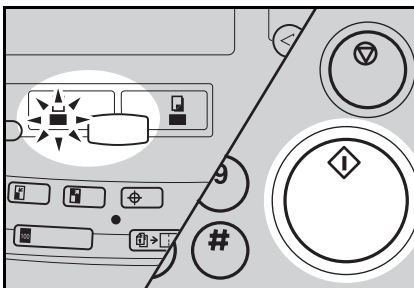

- 8** Make sure that **Print** indicator is lit and then press the **Start** key.

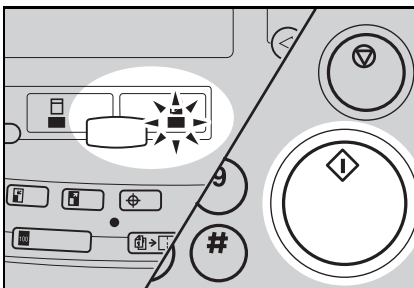

CHANGING DEFAULT SETTINGS (SERVICE PROGRAM MODE)

Printing needs may vary. To suit your applications, you can adjust the settings for certain functions.

How To Access Service Programs

The service programs can be set by following this procedure.

- ❑ If you want to change the settings of a selected service program, see page 95.
- ❑ For the service program menu, see page 102 ~ 107.

1 Press the **SP mode** key.

- ❑ The SP-mode menu appears on the guidance display.

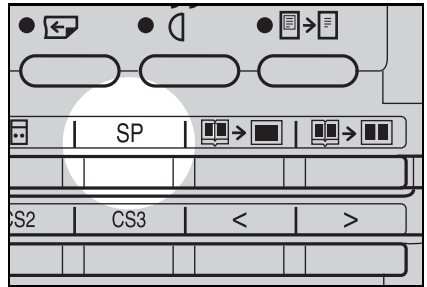

2 Using the **Number** keys, enter the desired service program number (SP No.).

- ❑ For the SP No., refer to pages 102 ~ 107.
- ❑ You can go back a menu or move on using the "<" and ">" keys.

3 When you want to leave the Service Program mode, press the **Clear Modes** key.

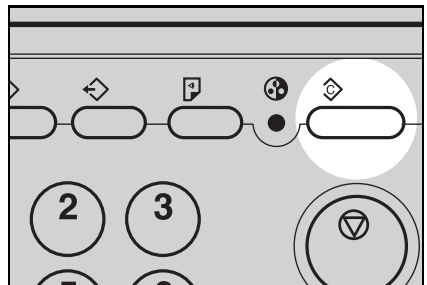

How To Change Settings of Service Programs

- You can register SP No. 5, 20, 29, 84 or 88 and their setting in the **CS Mode** key (☞ see page 96).

Procedure 1

- 1** After entering the desired SP No., press the **Enter** key. The value or mode set at the factory will be displayed at the end of the second line on the guidance display.

- If you designate the wrong SP No., press the **Clear Modes** key. Then, re-enter the desired SP No..

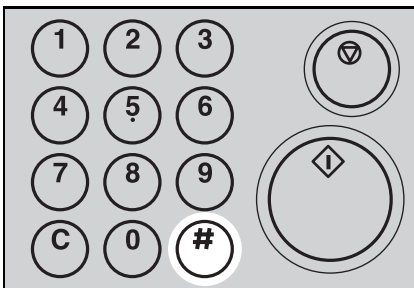

- 2** Enter the required value or mode using the **Number** keys.

- For the setting of each SP No., ☞ see page 102 ~ 107.



- 3** Press the **Enter** key to store the desired value or mode.

- If you enter the wrong value or mode, press the **Clear Modes** key. Then, go back to step 1.

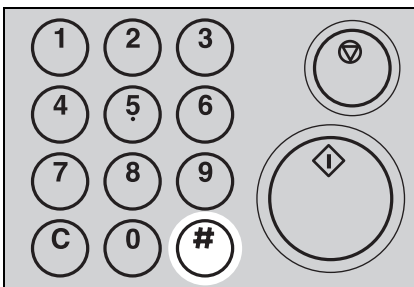

- 4** When you want to leave the Service Program mode, press the **Clear Modes** key twice.

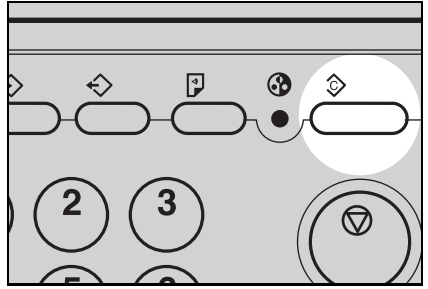

Procedure 2

You can change the settings of the following 4 service programs using procedure 2.

SP No.	Mode	Default
5	Tape Marker Off	0: No
20	Buzzer On	0: No
29	Photo Background correct	0: No
84	Auto Multi Copy mode selection	0: Multi Copy mode
88	Auto Class mode	0: No

SP No. 5, 20, 29, 84 and 88 can be registered in the **CS Mode** key. You can recall registered service programs and their settings and make prints using the **CS Mode** key.

- For about "Tape Marker Off", see page 102.
- For about "Buzzer On", see page 102.
- For about "Photo Background correct", see pages 99 and 104.
- For about "Auto Multi Copy mode selection", see pages 100 and 106.
- For about "Auto Class mode", see pages 101 and 106.

How to register SP modes and settings in the **CS Mode** key

- 1** Enter the service program mode and select the service program number you want to register.

☞ See page 94.

- 2** While pressing one of the **CS Mode** key that you want to register the SP mode, press the **Enter** key until the beeper sounds.

- ☐ Make sure that the previous function registered under the selected key is overwritten.

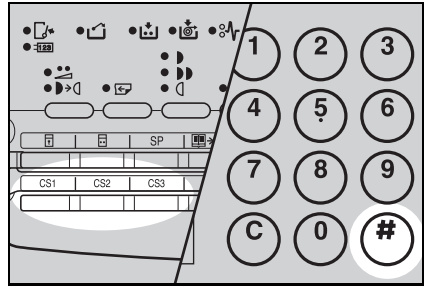

- 3** Press the **Clear Modes** key.

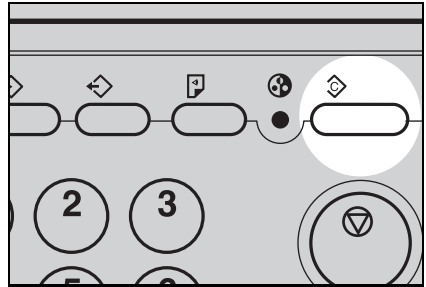

*How to make prints with the **CS Mode** key*

Photo Background Correct (Adjust background image in Photo or Letter/Photo mode)

□ About this mode, see page 104.

1 Set your originals on the exposure glass or in the optional document feeder.

2 Press the **CS mode** key you have registered as Photo Background Correct mode and select "BACKGROUND CORRECT ON".

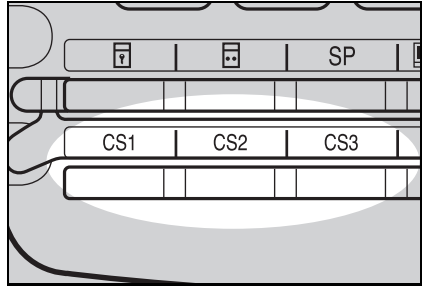

3 Select Photo or Letter/Photo mode.

4 Make sure that **Master Making** indicator is lit and then press the **Start** key. Check the image position of the trial or proof print.

□ If the image position is not correct, adjust it using the **Image Position** keys (see page 21) or the side plate fine adjusting dial (see page 22).

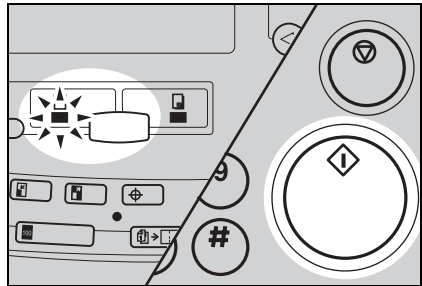

5 Enter the number of prints using the **Number** keys.

6 Make sure that the **Print** indicator is lit and then press the **Start** key.

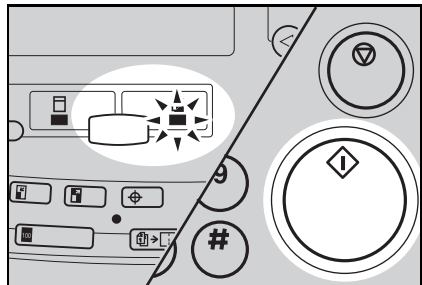

Auto Multi Copy mode

☐ About this mode, see page 106.

1 Set your original on the exposure glass or in the optional document feeder.

2 Press the **CS Mode** key you have registered Auto Multi Copy mode and select "AUTO MULTI COPY ON".

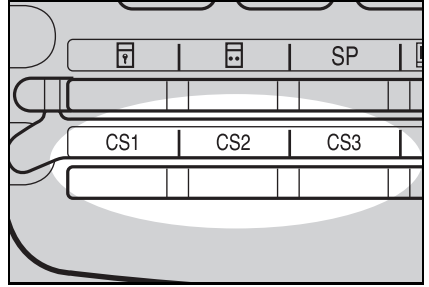

3 Press the **Combine 2 Originals** key.

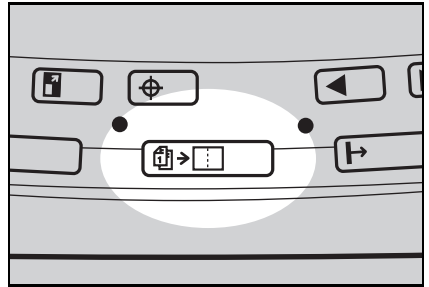

4 If you set your original on the exposure glass, follow the steps 3 to 10 on pages 65 ~ 67.

If you set your originals in the optional document feeder, follow the steps 3 to 6 on pages 85 ~ 86.

Auto Class mode

□ About this mode, see page 106.

1 Set your original on the exposure glass or in the optional document feeder.

2 Press the **CS mode** key you have registered Auto Class mode and select "AUTO CLASS MODE ON".

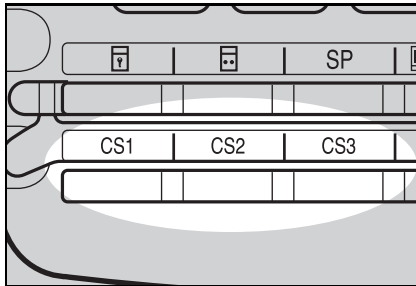

3 Follow the steps 2 to 8 on pages 57 ~ 59 or on pages 59 ~ 61.

Service Program Menu

SP No.	Mode	Function
5	Tape Marker Off	<p>If your machine is equipped with the optional tape dispenser and you want to use it, select "0".</p> <p><input type="checkbox"/> Default: 0</p> <p><input type="checkbox"/> Adjustable value: 0: No 1: Yes</p>
10	Minimum Print	<p>Specifies the minimum number of prints that can be input with the Number keys.</p> <p><input type="checkbox"/> Default: 0</p> <p><input type="checkbox"/> Adjustable value: 0 to 9999</p>
11	Maximum Print	<p>Specifies the maximum number of prints that can be input with the Number keys.</p> <p><input type="checkbox"/> Default: 9999</p> <p><input type="checkbox"/> Adjustable value: 0 to 9999</p>
12	Set Display Mode	<p>If you want to change the language used by the guidance display, select "1".</p> <p><input type="checkbox"/> Default: 0</p> <p><input type="checkbox"/> Adjustable value: 0: No 1: Yes</p> <hr/> <p>If you select "1" in Set Display Mode, then select the language version.</p> <p><input type="checkbox"/> Adjustable value:</p> <p>0: Japanese 1: English 2: German 3: French 4: Italian 5: Spanish</p>
20	Buzzer On	<p>Turns the buzzer ON or OFF.</p> <p><input type="checkbox"/> Default: 0</p> <p><input type="checkbox"/> Adjustable value: 0: No 1: Yes</p>

SP No.	Mode	Function
21	Prints/Master Cost	<p>The optional key counter usually counts the number of copies made regardless of the number of masters used. For accounting purposes, it is possible for the key counter to be incremented by a value between 0 and 50 whenever a new master is used.</p> <p><i>Example:</i> The key counter is adjusted to increase by 20 for each master fed. If 100 copies have been made and the master is replaced, the key counter will increase by 120.</p> <p><input type="checkbox"/> Default: 0</p>
22	Print Program Class	<p>You can select the order of print when printing using One Touch Class mode.</p> <p>If you select "0: First", the machine start printing from the first class you have selected. If you select "1: Last", the machine start printing from the last class you have selected.</p> <p><input type="checkbox"/> Default: 0: First</p> <p><input type="checkbox"/> Adjustable value: 0: First 1: Last</p>
23	Clear 1 Touch Class	<p>By default, after making prints with One Touch Class, the classes that you have selected remain selected ready for the next printing. If you want to set the machine to clear the classes after printing, select "1".</p> <p><input type="checkbox"/> Default: 0</p> <p><input type="checkbox"/> Adjustable value: 0: No 1: Yes</p> <p><input type="checkbox"/> Even if you select "1" in this mode, the classes are not cleared when the next originals are set in the optional document feeder.</p>
24	Clear CS Mode	<p>By default, pressing the Clear Modes key does not clear the SP modes registered in the CS Mode keys. If you want to clear the SP modes that are registered in the CS Mode keys by pressing the Clear Modes key, select "1".</p> <p><input type="checkbox"/> Default: 0</p> <p><input type="checkbox"/> Adjustable value: 0: No 1: Yes</p>

SP No.	Mode	Function
25	Clear 2 in 1	<p>By default, when master making is finished in Combine 2 Originals mode, this mode stays selected for the next master making. If you want to set the machine to clear this mode after the master making is finished, select "1".</p> <p><input type="checkbox"/> Default: 0</p> <p><input type="checkbox"/> Adjustable value: 0: No 1: Yes</p> <p><input type="checkbox"/> Even if you select "1" in this mode, Combine 2 Originals mode is not cleared when the next originals are set in the optional document feeder.</p>
29	Photo Background Correct	<p>When you make prints in Photo or Letter/Photo mode, the background of the prints may become dirty. You can prevent this using this function.</p> <p><input type="checkbox"/> Default: 0</p> <p><input type="checkbox"/> Adjustable value: 0: No 1: Yes</p>
40	Original	<p>Specifies the image mode at power on.</p> <p><input type="checkbox"/> Default: 0</p> <p><input type="checkbox"/> Adjustable value: 0: Letter mode 1: Letter/Photo mode 2: Photo mode</p>
41	Image Density	<p>Specifies the image density at power on.</p> <p><input type="checkbox"/> Default: 1</p> <p><input type="checkbox"/> Adjustable value: 0: Light 1: Standard 2: Dark 3: Darker</p>
42	Printing Speed	<p>Specifies the printing speed at power on.</p> <p><input type="checkbox"/> Default: 2</p> <p><input type="checkbox"/> Adjustable value: 0: 60 sheets/minute 1: 75 sheets/minute 2: 90 sheets/minute 3: 105 sheets/minute 4: 120 sheets/minute</p>

SP No.	Mode	Function
43	Auto Cycle Mode	<p>Specifies whether Auto Cycle mode is selected at power on.</p> <p><input type="checkbox"/> Default: 0</p> <p><input type="checkbox"/> Adjustable value: 0: No 1: Yes</p>
44	Start Mode Setting	<p>Specifies the mode (Master Making or Print) at power on.</p> <p><input type="checkbox"/> Default: 0</p> <p><input type="checkbox"/> Adjustable value: 0: Master Making 1: Print</p>
45	Standard Image Position	<p>Specifies the image position at power on.</p> <p><input type="checkbox"/> Default: 4</p> <p><input type="checkbox"/> Adjustable value:</p> <p>1: -15 mm (Shift the image position backward)</p> <p>2: -10 mm (Shift the image position backward)</p> <p>3: -5 mm (Shift the image position backward)</p> <p>4: 0 mm</p> <p>5: +5 mm (Shift the image position forward)</p> <p>6: +10 mm (Shift the image position forward)</p> <p>7: +15 mm (Shift the image position forward)</p>
81	Quality Start No.	<p>You can select how many times Quality Start mode is carried out for each master making. When you set the Quality Start function, the bold letters or solid images may be light.</p> <p><input type="checkbox"/> Default: 1</p> <p><input type="checkbox"/> Adjustable value: 0 to 3 times</p> <p><input type="checkbox"/> For about Quality Start mode, see page 80.</p>
82	Skip Feed number	<p>When you use the Skip Feed Printing function, you can select how many times the drum rotates while one sheet of paper is fed.</p> <p><input type="checkbox"/> Default: 2 times</p> <p><input type="checkbox"/> Adjustable value: 1 to 9 times</p>

SP No.	Mode	Function
84	Auto Multi Copy	<p>If you set an original on the exposure glass and press the Combine 2 Originals keys and Start key, two identical images are printed on the one sheet.</p> <p><input type="checkbox"/> Default: 0</p> <p><input type="checkbox"/> Adjustable value: 0: No 1: Yes</p> <p><input type="checkbox"/> For how to make prints in Combine 2 Originals mode, see pages 63 ~ 70.</p>
88	Auto Class mode	<p>In this function, the machine stops printing for 2 seconds after one set of prints are completed in One Touch Class mode. This gives you the chance to separate each set when you do not have an optional tape dispenser. For example, you can remove prints one by one from the paper delivery table or insert one sheet of paper between the prints.</p> <p><input type="checkbox"/> Default: 0</p> <p><input type="checkbox"/> Adjustable value: 0: No 1: Yes</p>
113	Resettable Count Master/Print	<p>Used to display the total number of masters and prints.</p> <p><input type="checkbox"/> M: Total number of masters P: Total number of prints</p>
114	Clear Resettable Count Master/Print	<p>Clears the resettable master/print counter.</p> <p><input type="checkbox"/> Default: 0</p> <p><input type="checkbox"/> Adjustable value: 0: No 1: Yes</p>
120	User Code Mode	<p>Selects user code mode. For details about user code mode, see page 109.</p> <p><input type="checkbox"/> Default: 0</p> <p><input type="checkbox"/> Adjustable value: 0: No 1: Yes</p>
121	User Code Count	<p>Displays the number of masters and prints made in each user code.</p> <p><input type="checkbox"/> M: Number of masters P: Number of prints</p>
122	Clear User Code Count	<p>Clear each user code counter.</p> <p><input type="checkbox"/> Default: 0</p> <p><input type="checkbox"/> Adjustable value: 0: No 1: Yes</p>

SP No.	Mode	Function
123	Total User Code Count	Displays the total number of masters and prints for all the 20 user codes. <input type="checkbox"/> M: Number of masters <input type="checkbox"/> P: Number of prints
124	Clear Total User Code Count	Clears the total user code counter. <input type="checkbox"/> Default: 0 <input type="checkbox"/> Adjustable value: 0: No 1: Yes
160	Side Erase	Adjust the default side edge margin width in Edge Erase and Center Erase mode. <input type="checkbox"/> Default: Metric version: 5 mm Inch version: 0.2" <input type="checkbox"/> Adjustable value: Metric version: 2 ~ 20 mm Inch version: 0.1" ~ 0.8"
161	Center Erase	Adjust the default center margin width in Center Erase mode. <input type="checkbox"/> Default: Metric version: 10 mm Inch version: 0.4" <input type="checkbox"/> Adjustable value: Metric version: 4 ~ 60 mm Inch version: 0.2" ~ 2.3"
162	Horizontal Erase	Adjust the default horizontal edge (top and bottom) margin in Edge Erase and Center Erase mode. <input type="checkbox"/> Default: Metric version: 5 mm Inch version: 0.2" <input type="checkbox"/> Adjustable value: Metric version: 2 ~ 20 mm Inch version: 0.1" ~ 0.8"
170	Erase.**1	If you want to frequently use non-standard sized originals in Edge Erase and Center Erase/Edge Erase mode, you can program up to 3 sizes. <input type="checkbox"/> Default: Metric version: 0 x 0 mm Inch version: 00.0" x 00.0" <input type="checkbox"/> Adjustable range: Metric version: (100 ~ 258 mm) x (100 ~ 364 mm) Inch version: (4.0" ~ 10.0") x (4.0" ~ 14.3")
171	Erase.**2	
172	Erase.**3	

Entering decimal values in SP No. 160 ~ 162 and 170 ~ 172

- Press the **Program** key to enter a decimal point.
- Press the **Enter** key to fix the value.

For example, if you want to enter 8.4" x 10.5" in SP No. 170, do the following steps (P: Program key, #: Enter key):

	Key input	Display
1.	8 P 4	8.4 x 00.0 (8.4 is blinking)
2.	#	8.4 x 00.0 (8.4 is fixed and 00.0 is blinking)
3.	10 P 5	8.4 x 10.5 (10.5 is blinking)
4.	#	(Complete)

User Codes

With the user code function, operators must input an authorized code before the machine will operate. The machine keeps track of the number of prints made under each code. In this mode, the following 20 user codes (fixed) can be used to access the machine.

382, 191, 182, 173, 164, 155, 146, 137, 128, 119, 482, 291, 282, 273, 264, 255, 246, 237, 228, 219

- To prevent unauthorized users from accessing the machine, note down the codes and then black out the codes from this manual.

How to enable user code mode (# 120)

The following procedure explains how to enable user code mode. This must be done before a user code can be input.

- 1** Press the **SP mode** key.

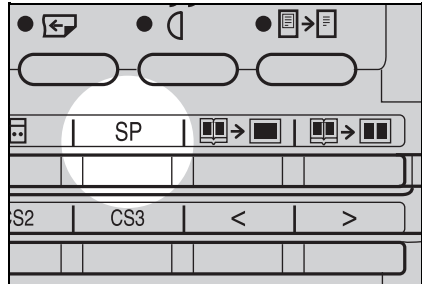

- 2** Enter "120" using the **Number** keys and press the **Enter** key.



- 3** Enter "1" (Yes) using the **Number** key and press the **Enter** key.

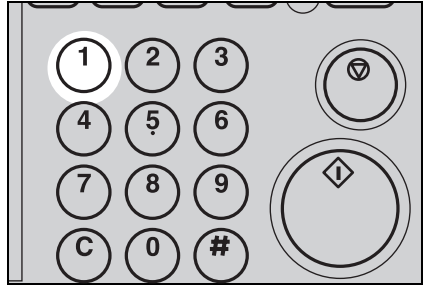

- 4** Specify the Auto Reset time. Enter the desired setting using the **Number** keys and press the **Enter** key.

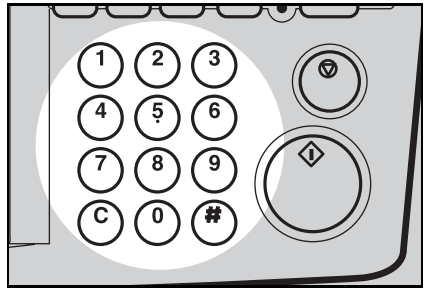

- 5** Press the **Clear Modes** key to leave Service Program mode.

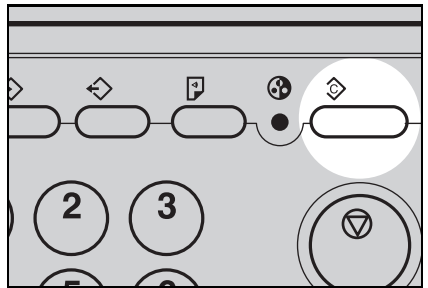

How to use user code mode

- 1** Input your assigned 3-digit user code using the **Number** keys, then press the **Enter** key.



- 2** Make your prints.

- 3** After you have finished, press the **Stop** key while pressing the **Clear Modes** key.

- This prevents others from using your user code to make prints.
- If you do not follow this step, the machine will not request the next user for their codes unless the auto reset time has expired.



How to check the user code counter (# 121)

- If you want to check the total masters and prints made under all user codes, see page 114.

1 Press the **SP mode** key.

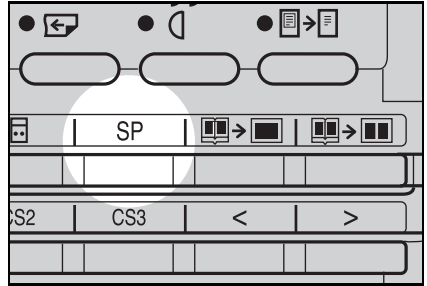

2 Enter "121" using the **Number** keys and press the **Enter** key. The number of masters and prints made under the user code "382" will be displayed in the guidance display.

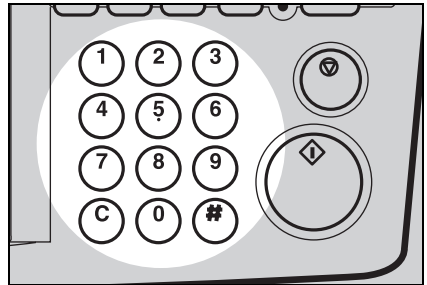

3 Continue pressing the **Enter** key to display the number of masters and prints made under your user code.

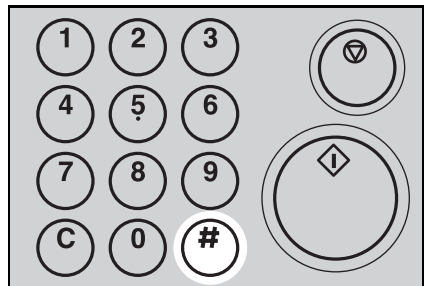

4 Press the **Clear Modes** key to leave Service Program mode.

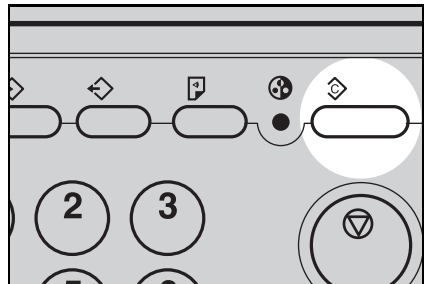

How to clear the user code counter (# 122)

- If you want to clear every user code counter, ← see page 115.

1 Press the **SP mode** key.

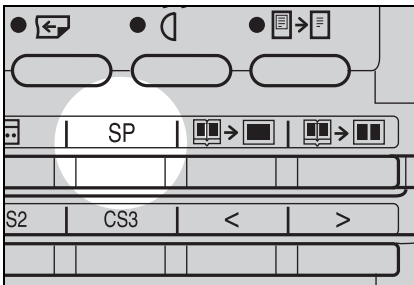

2 Enter "122" using the **Number** keys and press the **Enter** key.

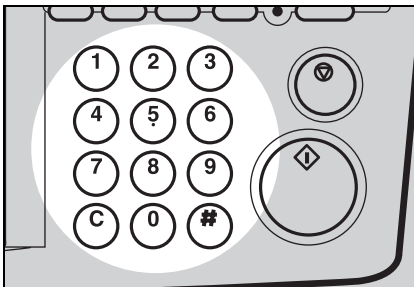

3 Keep pressing the **Enter** key until desired user code is displayed.

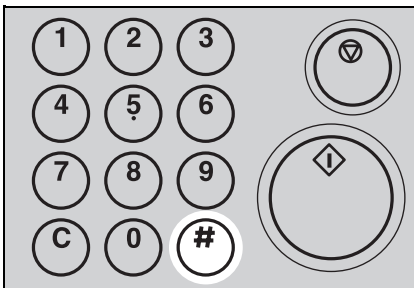

4 Enter "1" (Yes) using the **Number** key and press the **Enter** key.

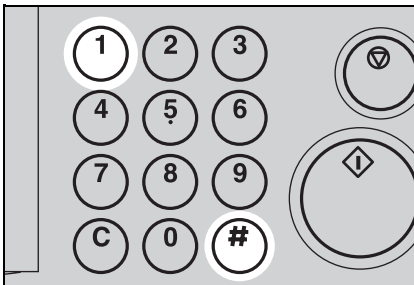

5 Press the **Clear Modes** key to leave Service Program mode.

How to check the total number of masters and prints made under all user codes (# 123)

- 1 Press the **SP mode** key.

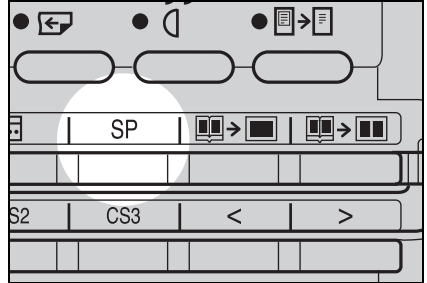

- 2 Enter "123" using the **Number** keys and press the **Enter** key.

- The total number of masters and prints made under all user codes will be displayed in the guidance display.

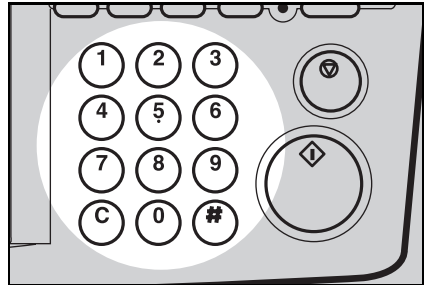

- 3 Press the **Clear Modes** key to leave Service Program mode.

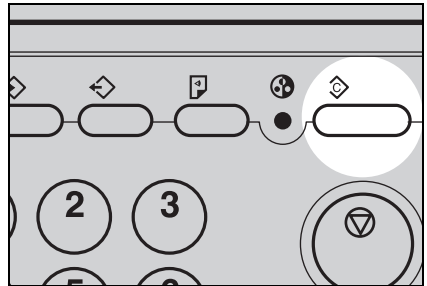

How to clear the user code total counter (# 124)

- 1** Press the **SP mode** key.

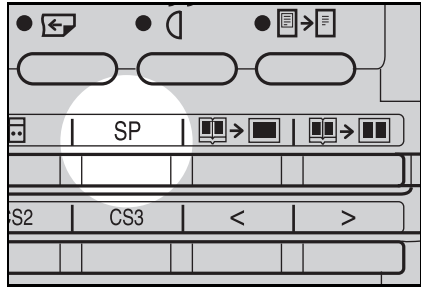

- 2** Enter "124" using the **Number** keys and press the **Enter** key.

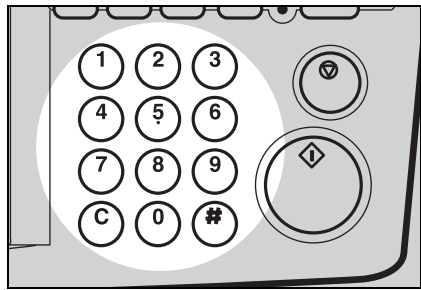

- 3** Enter "1" (Yes) using the **Number** key and press the **Enter** key.

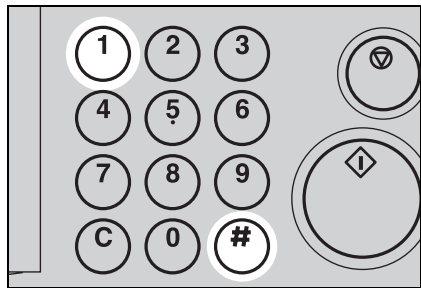

- 4** Press the **Clear Modes** key to leave Service Program mode.

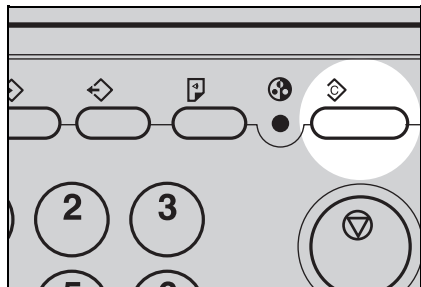

REPLENISHING SUPPLIES

Loading Paper On The Paper Feed Table

The Load Paper indicator () blinks when the paper feed table runs out of paper.

Replenishing paper

1 Press the **Stop** key.

- This step is necessary only if you want to pause a print run to replenish paper.

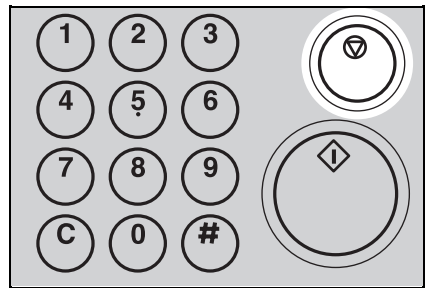

2 Press the **Lower** key.

- The paper feed table will lower without the key being pressed when the printing paper runs out.
- The top sheet might remain between the feed rollers. In this case, remove the top sheet.

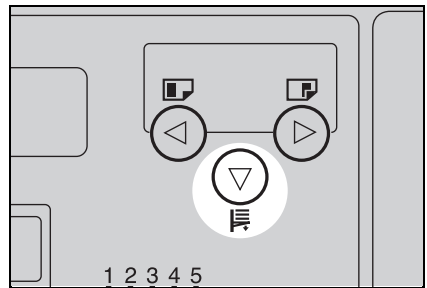

3 Load paper on the paper feed table.

- Release the pads of the feed side plates before loading paper. Reset the pads after the paper is set.
- Correct paper curl before setting the paper.

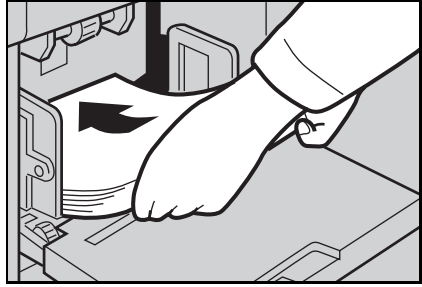

4 To resume printing, make sure that the **Master Making** indicator is lit and then press the **Start** key

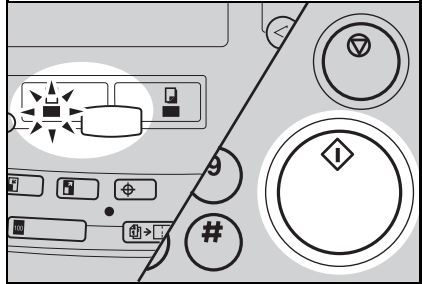

Changing the paper size

1 Remove the paper from the paper feed table.

- The paper feed tray will lower.



2 Adjust the paper feed side plates to match the paper size.

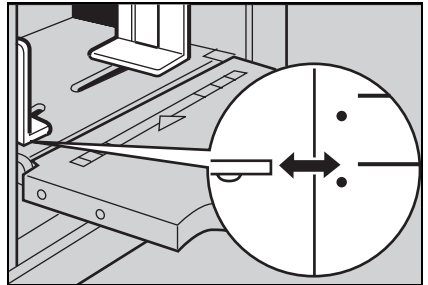

3 Place the paper on the paper feed table.

- Correct any paper curl before setting the paper.
- Make sure that the side plates contact the paper lightly.

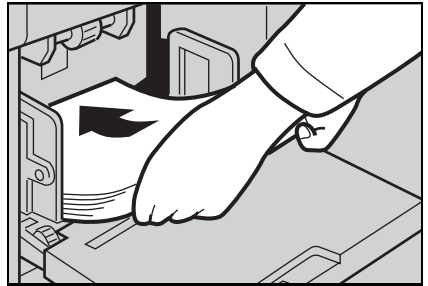

4 Adjust the side plates and the end plate and if necessary, the small size end plate at paper delivery table.

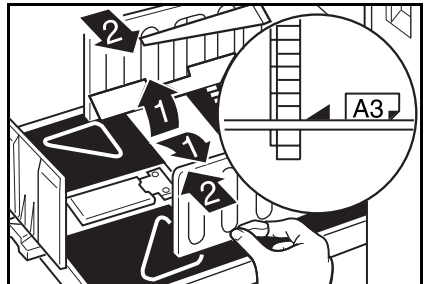

Supplying Ink

The Add Ink indicator () is lit when it is time to supply ink.

- 1** Open the front door.

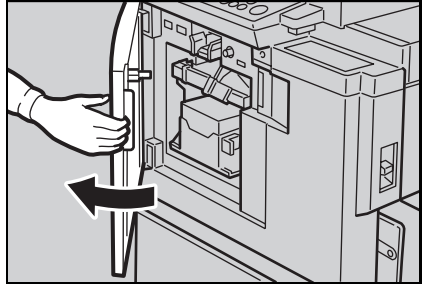

- 2** Lower the ink holder and remove the used ink cartridge.

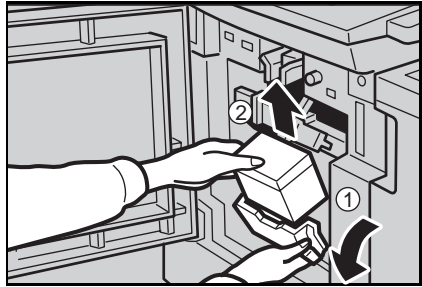

- 3** Remove the cap of the new ink cartridge.

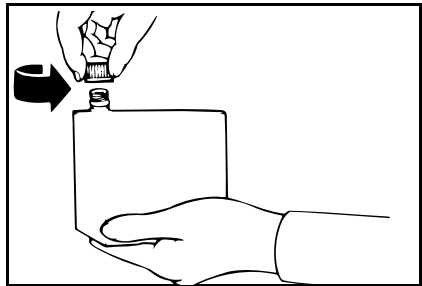

4 Insert the new cartridge into the ink holder. Return the ink holder to its original position until it clicks.

- Always supply ink of the same color.
- Make sure to firmly insert the part indicated by the arrow mark into the guide.

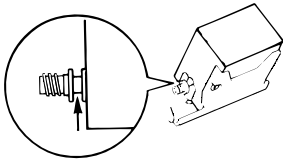
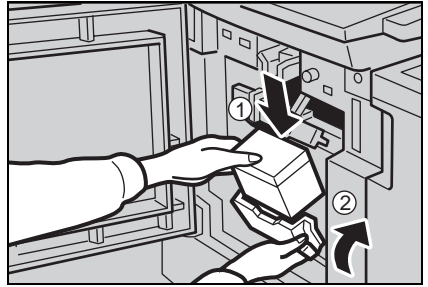

5 Close the front door.

6 Press the **Reset** key.

- The machine will start idling to supply ink to the drum. It will stop when the correct amount of ink reaches the drum.

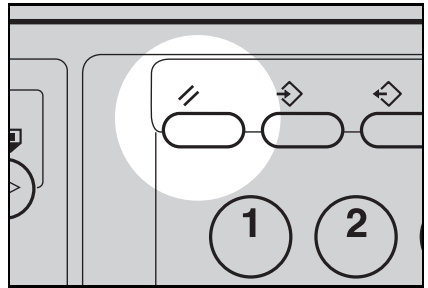

Master Roll Replacement

The Master End indicator (📶) is lit when it is time to replace the master roll.

1 Open the original table.

- ☐ Lift the original table release lever and lift the original table.

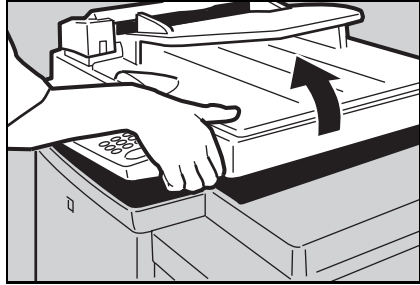

2 Open the right side cover.

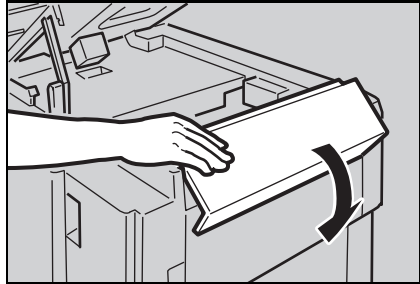

3 Lift the pressure release lever in the direction of the arrow to release the feed roller pressure.

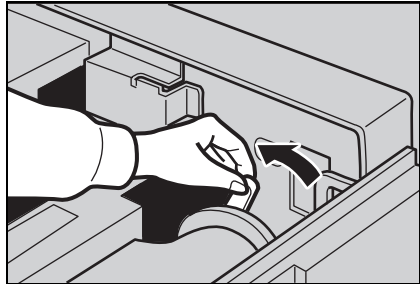

4 Remove the used master roll and pull out both spools. Then, insert both spools into a new master roll.

- ☐ When the Master End indicator lights, it is necessary to replace the master roll even if some master remains on the old roll.

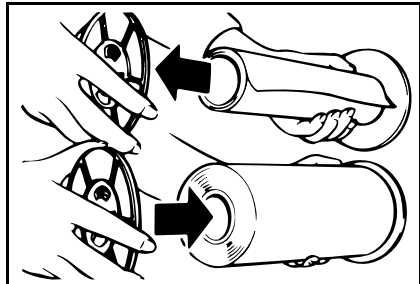

- 5** The new master roll must be positioned as shown in the illustration.

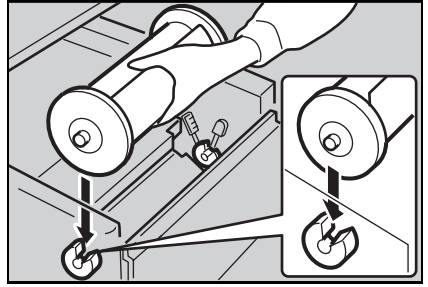

- 6** Insert the paper edge of the master roll under the arrow mark (1) until you can see the leading edge under the transparent cover.

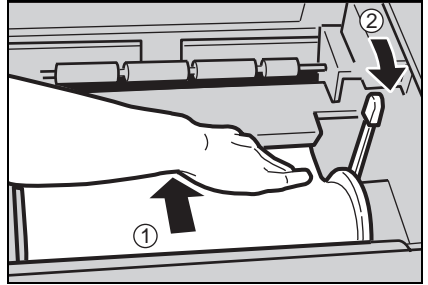

- 7** Return the pressure release lever to its original position (2).

- Rotate the spools backward to take up any slack in the master.

- 8** Press the master cut button to cut the leading edge of the master roll.

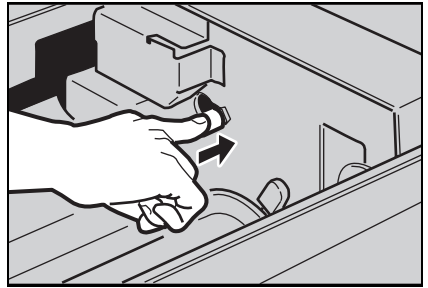

NOTE:

When the master cut button is pressed, the master roll will rotate. Do not touch the master roll.

- 9** After the beeper sounds, remove the cut-off portion of the master roll.

- Remove the cut-off master completely to prevent master misfeed.

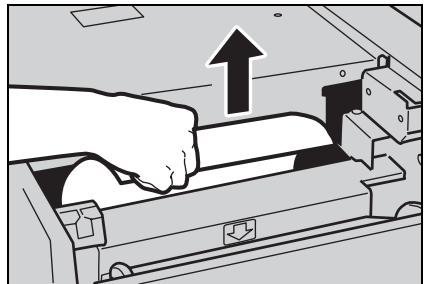

10 Close the right side cover.

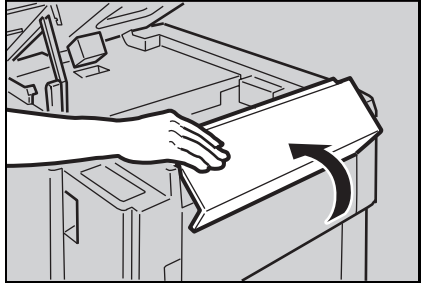

11 Return the original table to its original position.

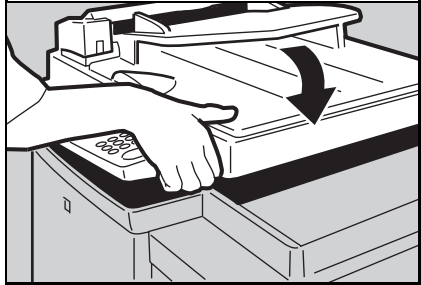

Placing A New Roll Of Tape In The Tape Dispenser (Option)

- ❑ Make sure that the main switch is turned on and the tape power switch is off.

- 1** Open the cover of the tape dispenser.

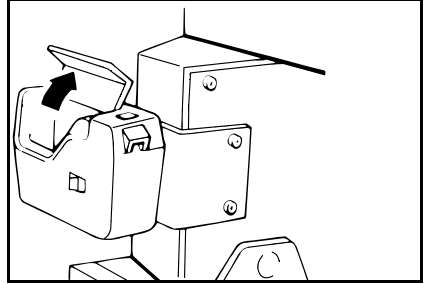

- 2** As shown, put the roll in the dispenser.

- ❑ Make sure that the tape is installed in the proper direction. If it is not in the correct direction, the tape dispenser will not work correctly.

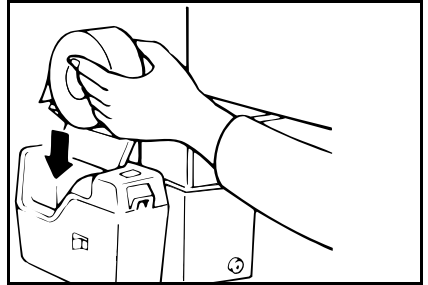

- 3** Feed the leading edge of the roll in the dispensing slot until it stops.

- ❑ Push the tape as far as possible through the slot.

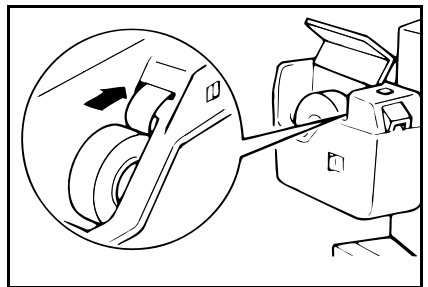

- 4** Turn on the power switch of the tape dispenser.

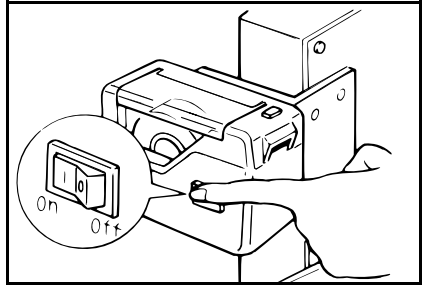

- 5** Press the manual cut button to trim off the leading edge of the tape.

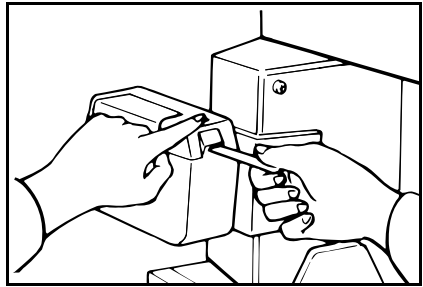

DAILY MAINTENANCE

To maintain high print quality, clean the following parts and units regularly.

Exposure Glass

Clean the exposure glass with a damp cloth and wipe it with a dry cloth.

- ❑ If you do not clean the exposure glass, marks on the glass will be printed.

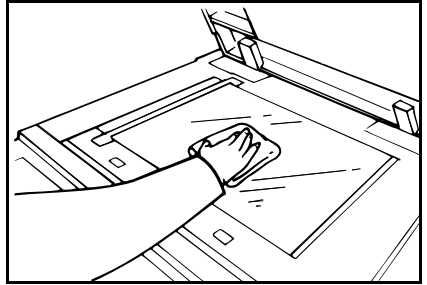

Platen Cover

Clean the platen cover with a damp cloth and wipe it with a dry cloth.

- ❑ If you do not clean the platen cover, marks on the cover will be printed.

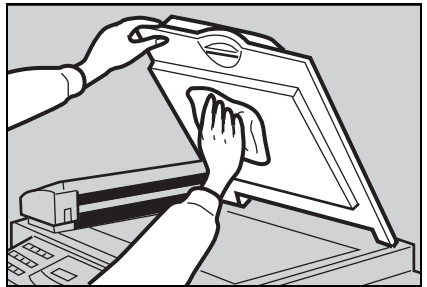

Separation Roller (Optional Document Feeder)

Clean the separation roller with a damp cloth and wipe it with a dry cloth.

- ❑ If you do not clean the separation roller, original misfeeds tend to occur.

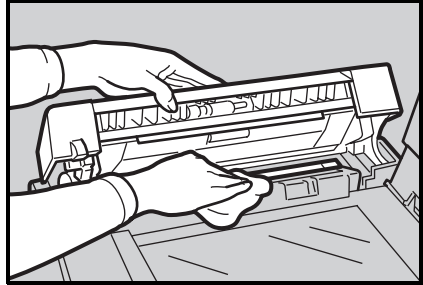

Paper Feed Roller (Paper Feed Table)

Wipe off the paper dust on the paper feed roller with a damp cloth, then wipe it with a dry cloth.

- ❑ If you do not clean the paper feed roller, paper misfeeds tend to occur.

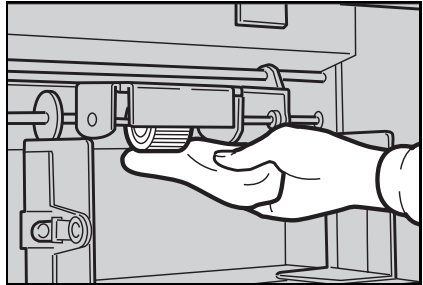

TROUBLESHOOTING

If a malfunction or a misfeed occurs within the machine, the following indicators will be lit.

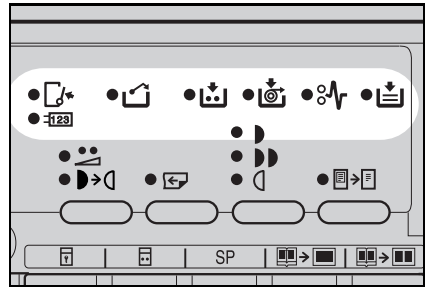

When the misfeed indicator (⚡) is lit

Indicator	Guidance Display	Page
⚡	ORIGINAL JAM REMOVE ORIGINAL	132
⚡	PAPER FEED JAM REMOVE JAMMED PAPER	134
⚡	MASTER FEED JAM REMOVE JAMMED MASTER	139
⚡	PAPER WRAP JAM REMOVE JAMMED PAPER	141
⚡	MASTER EJECT JAM REMOVE JAMMED MASTER	144
⚡	DELIVERY JAM REMOVE JAMMED PAPER	147

NOTE: Be careful not to cut yourself on any sharp edges when you reach inside the machine to remove misfed sheets of paper or masters.





NOTE: Remaining bits of misfed paper or masters will cause more misfeeds and may eventually cause a serious failure. If you tear the paper when removing it, make sure to remove all the torn pieces.

NOTE: Do not turn off the main switch while removing the misfed items.

When the open cover/unit indicator () is lit

Indicator	Guidance Display and Action	Page
	CLOSE THE COVER <ul style="list-style-type: none"> ➤ Close the original table unit. ➤ Close the front door. ➤ Close the master eject unit. 	148
	CLOSE THE ADF COVER <ul style="list-style-type: none"> ➤ Close the optional ADF unit. 	
	SET THE DRUM COMPLETELY	149

When the supply/exchange indicators are lit

Indicator	Guidance Display and Action	Page
	LOAD MORE PAPER	116
	LOAD NEW INK CARTRIDGE	119
	LOAD NEW MASTER ROLL	121
	EMPTY MASTER EJECT BOX <ul style="list-style-type: none"> ➤ Remove the used master. 	150
	SET THE MASTER EJECT BOX	

When other indicators blink

Indicator	Guidance Display and Action	Page
	SET THE KEY COUNTER	152

When one of the following messages is displayed on the guidance display:

Guidance Display	Meaning and action
RE-ENTER COPY NUMBER MAXIMUM IS XXXX	The maximum number of prints that can be entered is specified by the Service Program mode. Change the number of prints.
RE-ENTER COPY NUMBER MINIMUM IS XXXX	The minimum number of prints that can be entered is specified by the Service Program mode. Change the number of prints.
SET THE ORIGINAL	Make prints after you confirm whether there is an original or a command sheet on the exposure glass.
INPUT YOUR ID CODE	User Code mode is set. Before printing, enter your user code.
NO ADDITIONAL PRINTS ALLOWED	Security mode is set. If you make the next master, Security mode is canceled.
MASTER MAKING HALTED PRESS RESET KEY	Master making is halted. Press the Reset key.

When a service code (E-XX) is displayed in the counter

Turn the main switch off and on. If a service code appears again, contact your service representative.

NOTE: If a service code appears on the counter after you turn the main switch off and on a few times, do not continue turning it on and off. Leave the machine off.

When The Misfeed Indicator (3rd) Is Lit

After clearing misfeeds

Press the **Reset** key to reset the error indicators.

- ❑ Do not turn off the main switch when removing misfeeds.
- ❑ When original misfeed occurs in the optional document feeder, the error indicator will be reset by opening and closing the ADF unit.

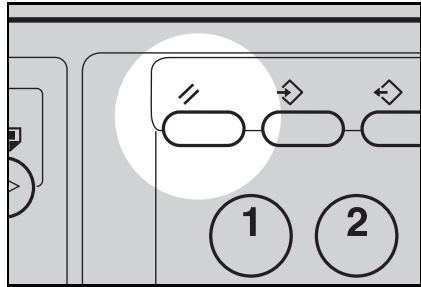

"" + "ORIGINAL JAM. REMOVE ORIGINAL"

Original misfeed occurs when using the optional document feeder.

- If you set originals in the document feeder and then turn on the main switch, the misfeed indicator will be lit. In this case, remove the originals, then open and close the ADF unit to reset the error indicator.

- 1** Press the ADF unit open lever and open the ADF unit.

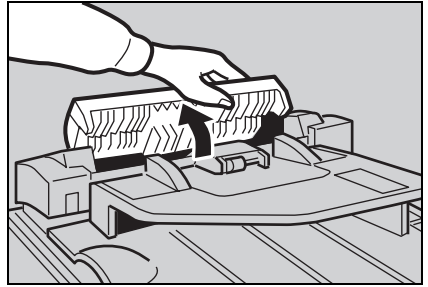

- 2** Pull out the original gently.

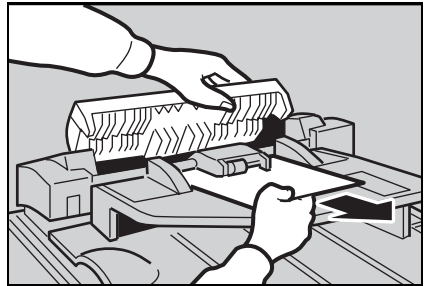

- 3** If you cannot remove the misfed original, open the platen cover and pull out the original.

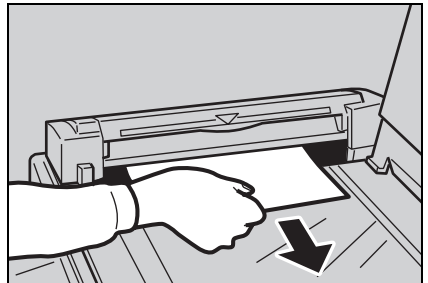

- 4** If you still cannot remove the misfed paper, push the ADF unit open lever and open the document feeder. Then remove the original.

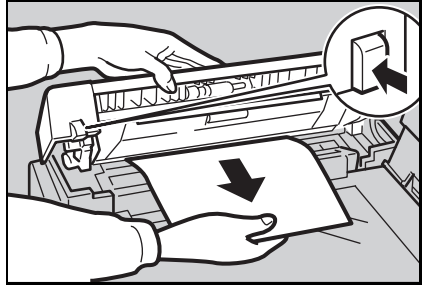

- 5** Close the ADF unit until it locks in position.

To prevent original misfeeds:

- The following types of originals are not recommended for use with the document feeder. Place them directly on the exposure glass.
 - Originals heavier than 90 g/m², 23.9 lb (when setting a stack of originals)
 - Originals lighter than 50 g/m², 13.3 lb (when setting a stack of originals)
 - Originals heavier than 120 g/m², 31.9 lb (when setting one original at a time)
 - Originals lighter than 40 g/m², 10.6 lb (when setting one original at a time)
 - Carbon coated originals
 - Damaged originals
 - Originals with glue on them
 - Originals perforated for ring binders
 - Book originals
 - Folded, curled, or creased originals
 - Bound, stapled, or clipped originals
 - Originals smaller than 148 mm x 105 mm, 5.8" x 4.1"
 - Originals larger than 257 mm x 364 mm, 10.2" x 14.4"
- Do not mix different sizes of originals in the optional document feeder.
- Clean the separation roller if it is dirty. (A dirty separation roller may slip and cause original misfeeds.)
- Remove staples or clips of originals. Fan originals that have had staples or clips removed.

"" + "PAPER FEED JAM. REMOVE JAMMED PAPER"

Misfed in the paper feed section

- 1** Slowly but firmly pull out the paper.

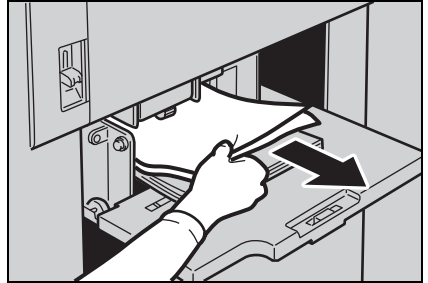

Paper is wrapped around the drum

- 1** Push the master eject unit open button and open the master eject unit.

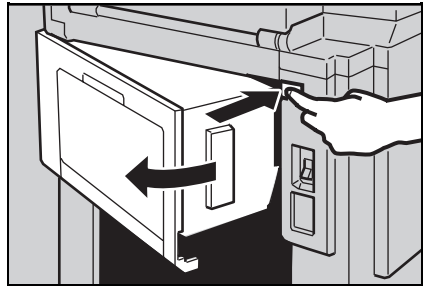

- 2** Remove the misfed paper.

- 3** If the paper is completely wrapped around the drum, peel off the edge of the paper. Then, close the master eject unit and press the drum rotation button until the lamp turns green again. And then, open the master eject unit and remove the misfed paper.

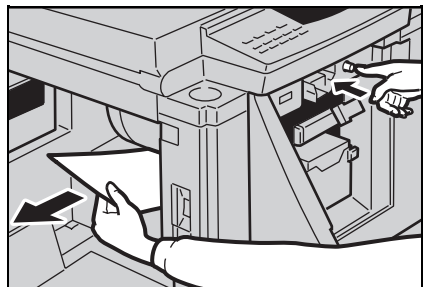

- 4** If you cannot remove the misfed paper, pull out the drum unit and remove the misfed paper from the drum.

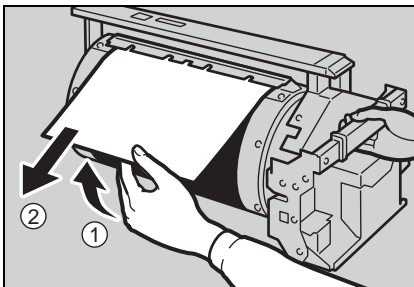

- 5** Close the master eject unit. If you follow step 3 or 4, close the front door.

- 6** Press the **Reset** key.

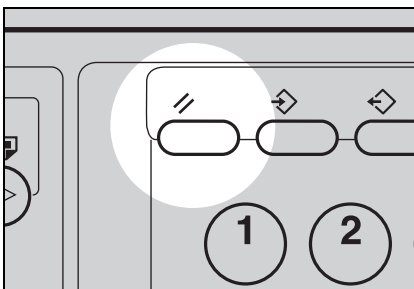

Check the following adjustments before restarting the printing run.

1 Is the paper feed pressure properly adjusted?

- The standard position of the pressure lever is up. If your paper applied to "Thick" in the table below, push the lever down.

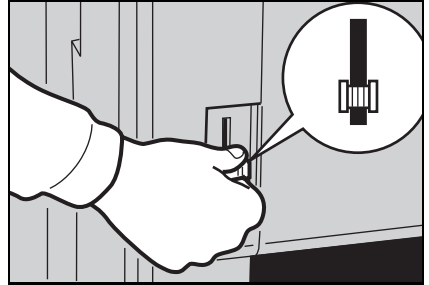

Is the separation roller pressure properly adjusted?

- The standard position of the separation pressure levers is the lower position. If your paper applied to "Thick" in the table below, push the levers up.

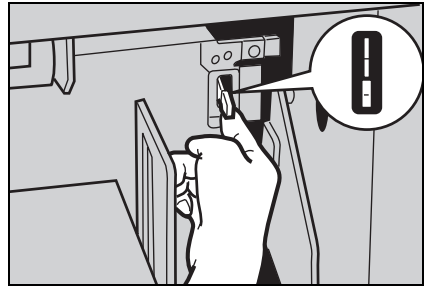

Weight \ Size	B4	A4	B5
209.3 g/m ² , 55.6 lb	Thick		Standard
157.0 g/m ² , 41.7 lb	Thick	Standard	
127.9 g/m ² , 34.0 lb	Thick	Standard	
47.1 g/m ² ~ 105 g/m ² 12.5 lb ~ 28 lb	Standard		

2 Are the side plate pads in the correct positions?

- To print on thin paper, slide the levers (behind the paper feed side plates) in the direction of the arrow (see illustration).

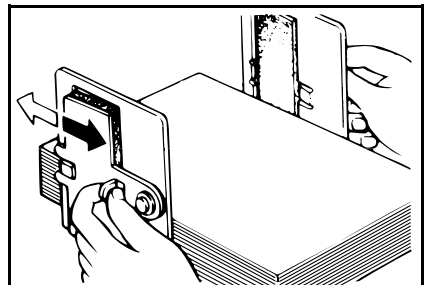

To prevent paper feed misfeeds:

When paper is curled, correct the curl as shown.

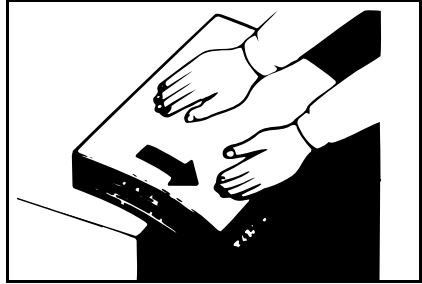

When paper edges stick together, shuffle the paper as shown.

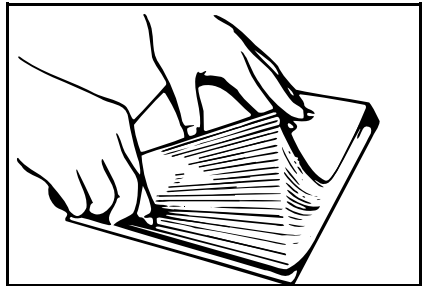

When you use post cards and thick paper, lower the printing speed to step 2 or 1. (☞ See page 24.)

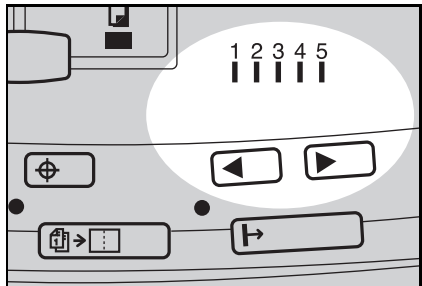

If the paper is curled or the original's leading edge margin is too narrow, the following action is necessary.

When you use curled paper, correct the curl as shown.

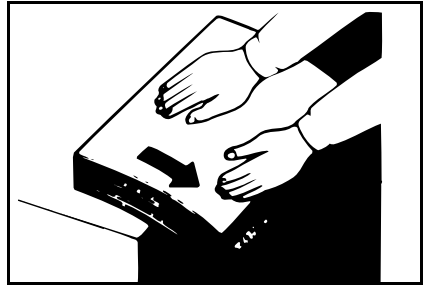

If you cannot correct the paper curl, stack the paper with the curl face down as shown.

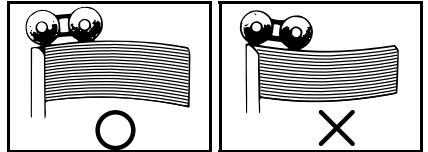

When the leading edge margin of the original is less than 5 mm, 0.2" or there is a solid image on the leading edge, insert the original with the widest margin first or make a leading edge margin by making a copy.

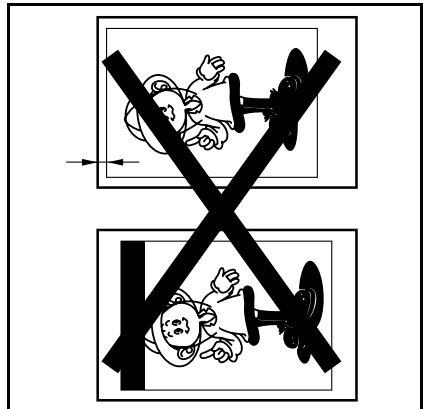

" " + "MASTER FEED JAM. REMOVE JAMMED MASTER"

1 Open the original table.

- Lift the original table release lever and lift the original table.



2 Open the right side cover.

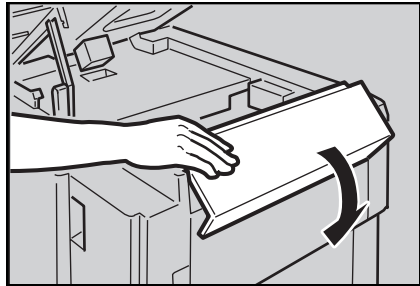

3 Pull the misfed master up and remove it.

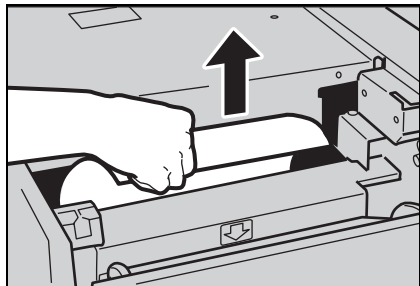

4 If you could not remove the misfed master in steps 2 and 3, take out the drum and remove the misfed master from the inside.

- For how to take out the drum unit, see page 89.

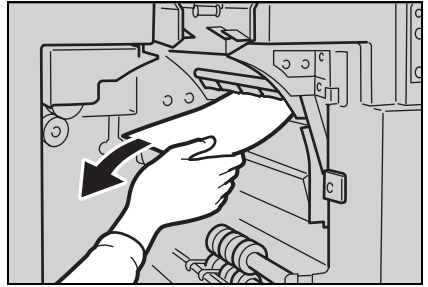

5 If the original misfeeds in the optional document feeder, press the ADF open lever and open the ADF unit to remove the misfed sheet.

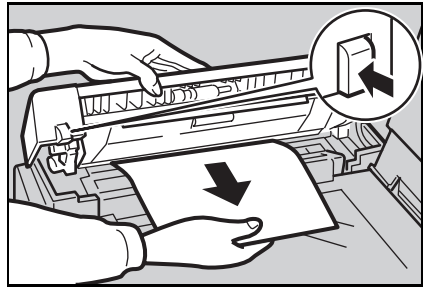

6 Return the original table to its original position.
If you follow step 4, set the drum unit and close the front door.
If you follow step 5, close the ADF unit.

" " + "PAPER WRAP JAM. REMOVE JAMMED PAPER"

- 1** Push the master eject unit open button and open the master eject unit.

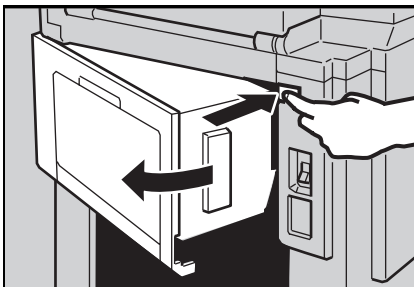

- 2** Remove the misfed paper.

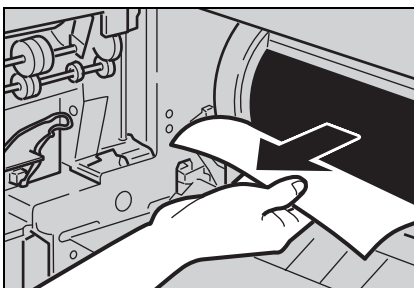

- 3** If the paper is completely wrapped around the drum, peel off the edge of the paper. Then, close the master eject unit and press the drum rotation button until the beeper sounds. And then, open the master eject unit and remove the misfed paper.

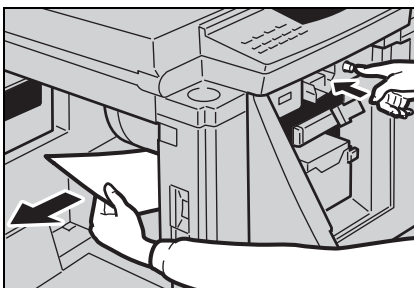

- 4** If you cannot remove the misfed paper, pull out the drum unit and remove the misfed paper from the drum.

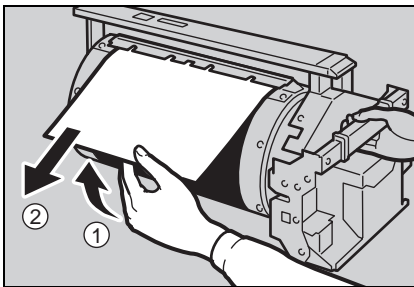

5 Close the master eject unit. If you follow step 4 or 5, close the front door.

6 Press the **Reset** key.

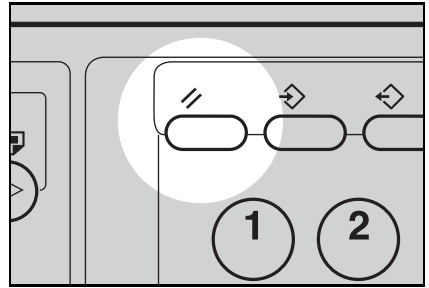

If the paper is curled or the originals leading edge margin is too narrow, the following action is necessary.

When you use curled paper, correct the curl as shown.

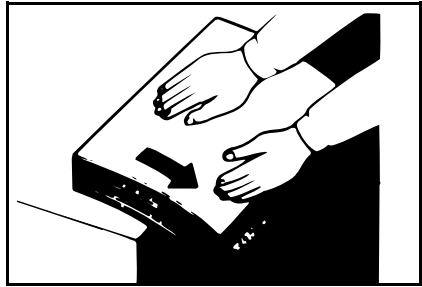

If you cannot correct the paper curl, stack the paper with the curl face down as shown.

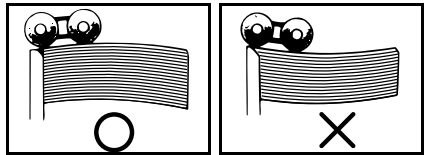

When the leading edge margin of the original is less than 5 mm, 0.2" or there is a solid image on the leading edge, insert the original with the widest margin first or make a leading edge margin by making a copy.

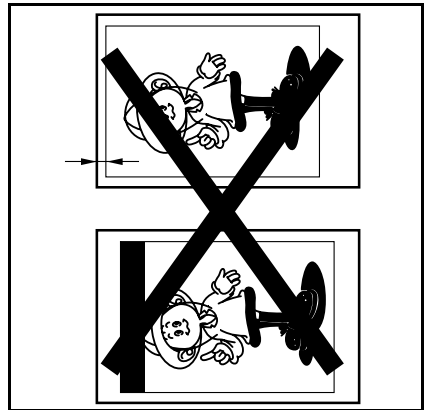

" 8A " + "MASTER EJECT JAM. REMOVE JAMMED MASTER"

Check where the misfeed is occurring

- 1** Press the master eject unit open button and open the master eject unit.
- 2** Check where the misfed master is. Remove the misfed master as follows.

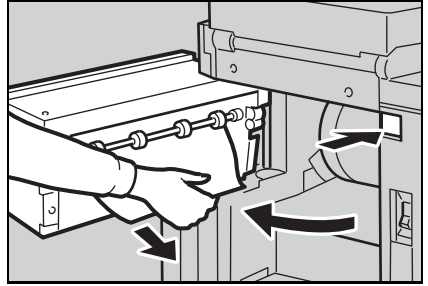

When a master misfeed occurs in the master eject section

- 1** Open the master eject container cover. Then, pull out the master eject box.

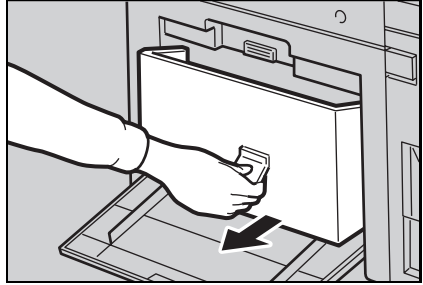

- 2** Remove the misfed master.

- Be careful not to stain your hands with ink when you touch used masters.



- 3** Return the master eject box to its original position and close the master eject container cover.

When a master misfeed occurs on the drum

1 Lift the lever to unlock the drum unit and pull out the unit.

- For how to remove the drum unit, see page 89.

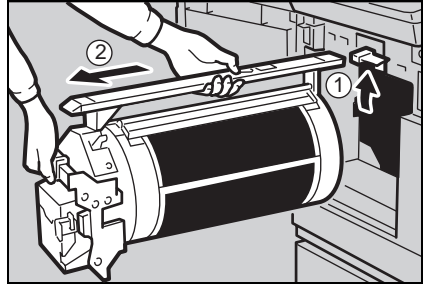

2 Grasp the drum unit handle and remove the master from the drum.

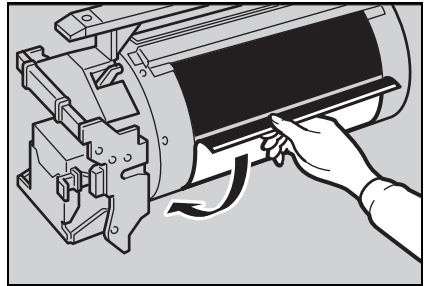

3 Pull the master out of the master clamp.

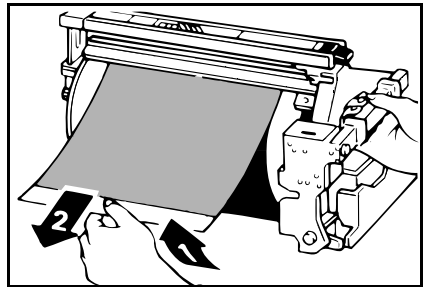

4 Re-insert the drum unit until the drum unit locks in position and put the lever back in place.

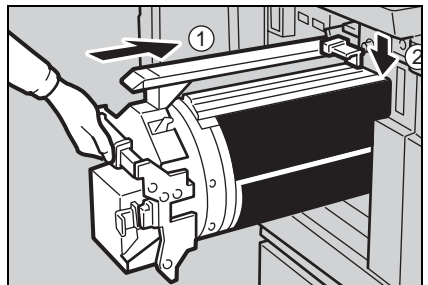

" 8A " + "DELIVERY JAM. REMOVE JAMMED PAPER"

- 1 Push the button to open the master eject unit.

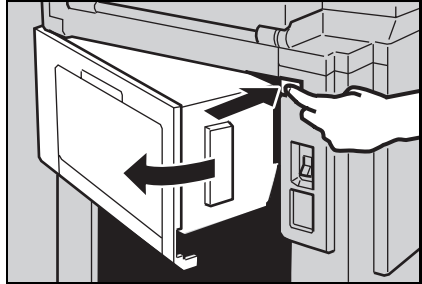

- 2 Remove the misfed paper.

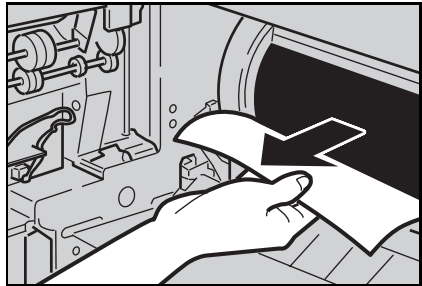

- 3 Close the master eject unit.

Check the following adjustment before restart operation

Is the paper delivery end plate in the correct position?

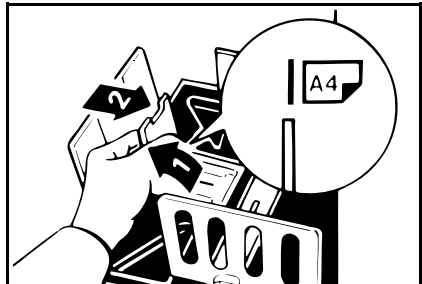

When The Open Cover/Unit Indicator () Is Lit

Make sure that the following door/units are closed.

Original Table

Close the original table until it locks in position.

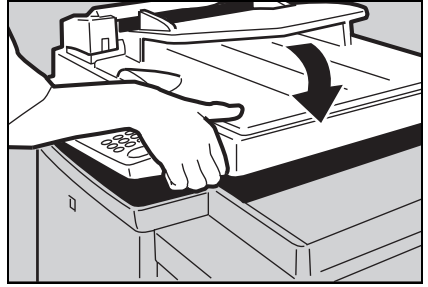

Front Door

Close the front door completely.

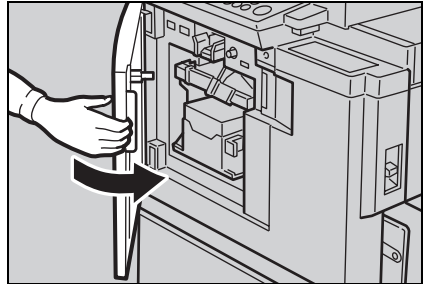

Master Eject Unit

Close the master eject unit until it locks in position.

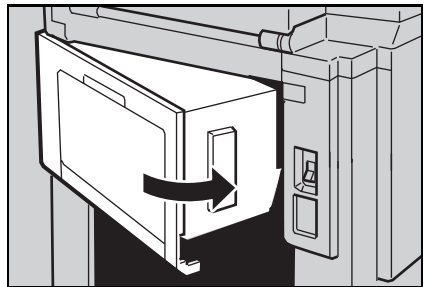

ADF Unit (Option)

Close the ADF unit until it locks in position.

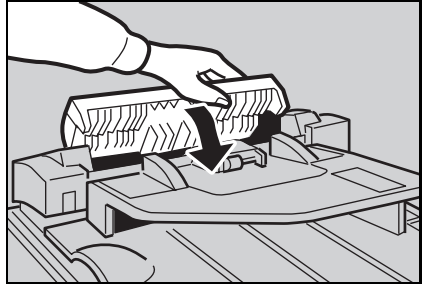

Make sure that the drum is completely set in position

Set the drum completely until it locks in position.

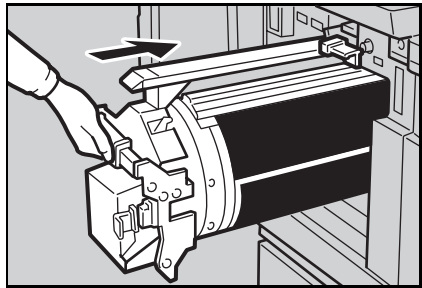

When The Supply/Exchange Indicators Are Lit

Load paper

➔ See page 116.

Load new ink cartridge

➔ See page 119.

Load new master roll

➔ See page 121.

Empty master eject box Set the master eject box

1 Open the master eject container cover.

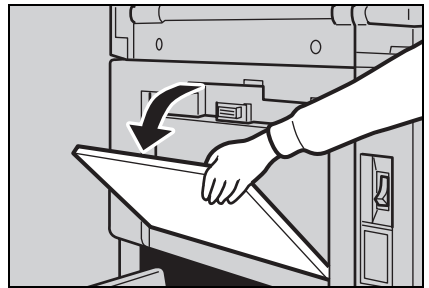

2 Take out the master eject box and remove the used masters.

- Spread an old newspaper, then turn the master eject box upside down on it to remove the used masters. Then, throw away the masters.

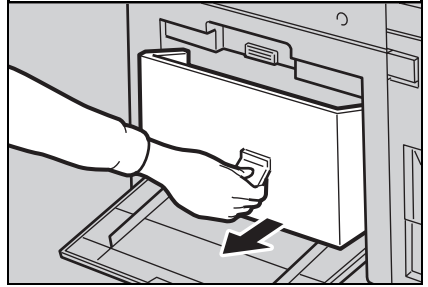

3 Reinstall the master eject box. Push in the box until it touches the inside bracket.

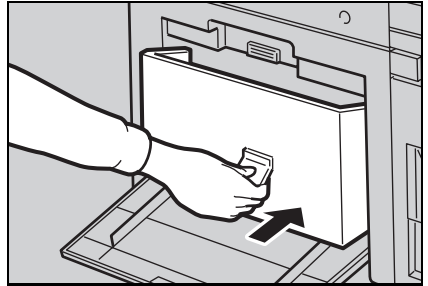

4 Close the cover of the master eject container.

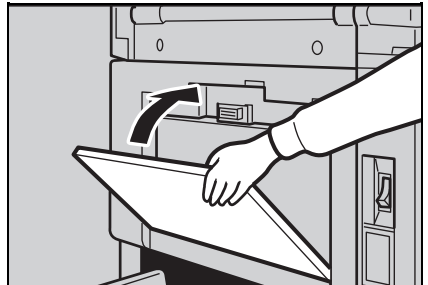

When Other Indicators Are Lit

123 Set the key counter

The key counter (option) is not set. Insert the key counter.

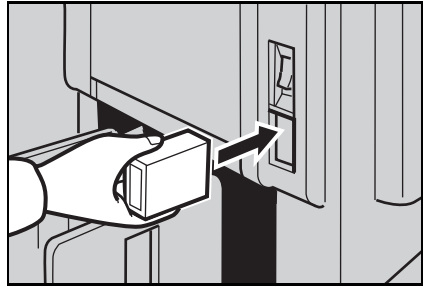

When The Prints Are Not Delivered In A Neat Stack, Or The Prints Are Thrown Over The Paper Delivery Table

Reduce the printing speed by pressing the "◀" key.

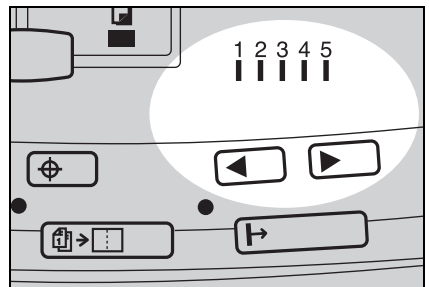

Poor Printing

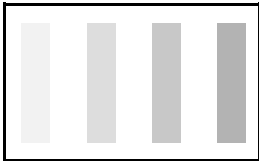

Dirty Background

- ❑ When you use paper smaller than the original, select the proper reduction ratio. Otherwise, you might get dirty background prints.
- ❑ When you use postcards and the like, the background might be dirty because postcards do not absorb ink well.
- ❑ You might get prints with dirty background when printing at high speed and under high temperature.

1 Turn off the main switch.



2 Pull out the drum unit. ← Refer to page 89 for the details.

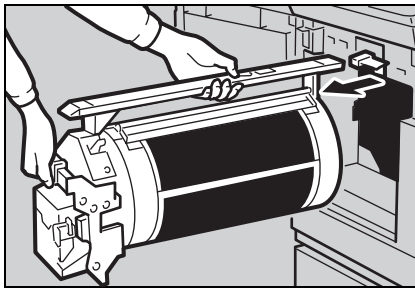

- 3** Clean the pressure roller with a clean cloth.

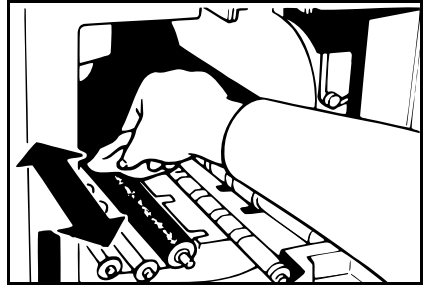

- 4** Remove with a clean cloth any ink that has accumulated on the trailing edge of the drum unit.

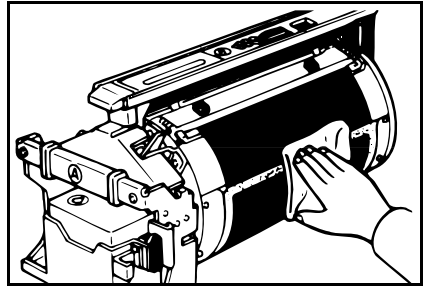

- 5** Insert the drum unit until it locks in position, then lower the drum unit lock lever.

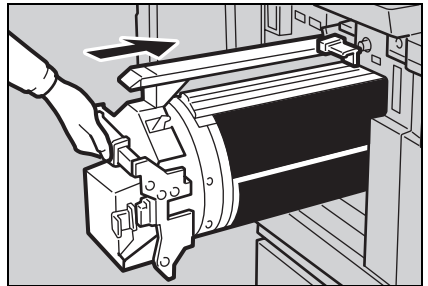

- 6** Close the front door.

- 7** Turn on the main switch.



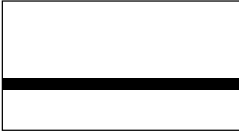

Black line/stain

- If there is no margin or if there is a solid image area near the leading edge of the original, make a margin of at least 5 mm, 0.2" at the leading edge. Otherwise, the paper exit pawl might become dirty and cause black lines on prints.

Check the following parts and clean them if they are dirty.

Platen cover. (☞ See page 126.)

Exposure glass. (☞ See page 126.)

When black lines or stains still appear on prints even if you clean the above, contact your service representative.

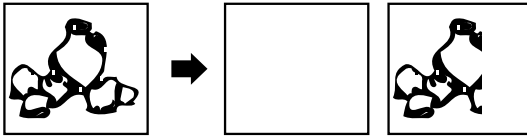

White prints or incomplete prints

Make sure that the paper feed side plates contact the paper lightly.

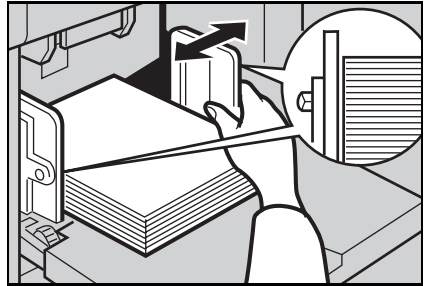

When you use the optional document feeder, make sure that the original guides contact the originals lightly.

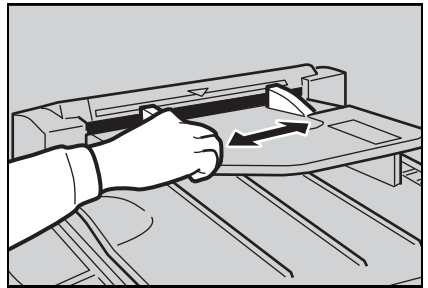

When you get white or incomplete prints even if you check the items on the previous page, perform the following procedure.

- 1** Pull out the drum unit. ← Refer to page 89 for the details.

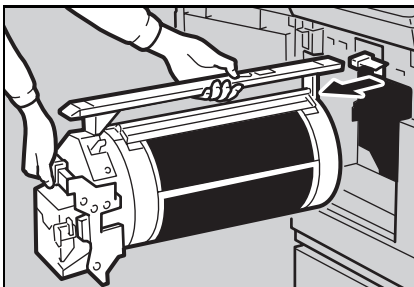

- 2** Remove the master from the drum.

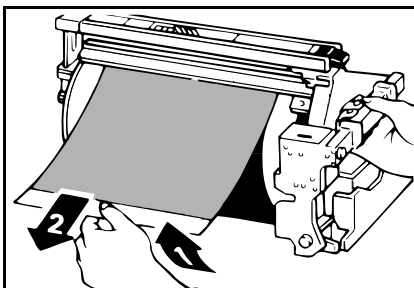

- 3** Remove paper that is stuck to the drum.

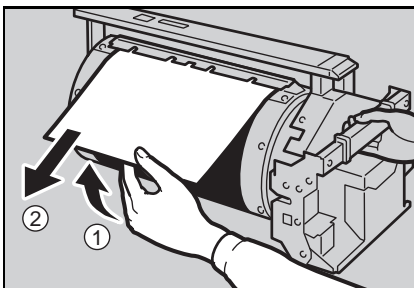

- 4** Insert the drum unit until it locks in position, then lower the drum unit lock lever.

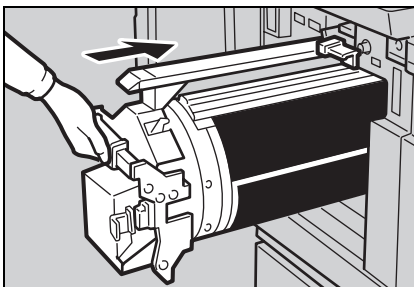

- 5** Close the front door.

OPERATION NOTES

General Cautions

- ❑ Make sure to make a few trial prints to check the image position because the image position of the trial print might not correspond with that of the original.
- ❑ The image position of the prints might slightly change when the printing speed is changed while printing.
- ❑ The leading edge of the prints might become stained if the edge touches the image of prints on the paper delivery table. In this case, remove paper from the paper delivery table.
- ❑ When performing duplex or multicolored printing, leave the printed paper for a while before the next printing in order to let the ink dry on the printed paper. If this is not done, feed roller marks will appear on the print image.
- ❑ If the machine is not used for a long period, the image density might decrease because the ink on the drum might dry. Make extra prints until the image density recovers.
- ❑ If the machine is not used for a long period, master misfeed might occur because the ink on the drum might dry. In this case, remove the old master from the drum. ← See page 146.
- ❑ The paper exit pawl might contact the printing paper and cause black lines on the prints. In this case, increase the printing speed or make a new master with lighter image density mode.
- ❑ The first print paper might not be delivered completely. In this case, remove it by hand before resuming printing.
- ❑ If you print on thick paper with slow speed, paper might not be delivered completely. In this case, increase the printing speed.
- ❑ The top sheet might remain between the feed rollers when you press the **Lower** key to lower the paper feed table. In this case, remove the top sheet.
- ❑ The ink of the print on the paper delivery table might stick to the back side of the next print. In this case, increase the printing speed.
- ❑ When the machine is used in low temperature conditions, the image density might decrease. In this case, increase the room temperature or slow the printing speed down to step 1 or 2.
- ❑ The image density varies according to the printing speed and the room temperature. So, adjust the printing speed or increase the room temperature.

- ❑ The outer portion of the image might not be printed under low temperature. In this case, increase the room temperature or slow the printing speed down to step 1 or 2.
- ❑ When you use originals with screened image in Letter mode, stripe patterns might appear on the prints. In this case, make masters in Letter/Photo mode.
- ❑ When you use originals with light lettering, edges of the letters may be printed clearly and the inside of the letters may be light. In this case, increase the image density.
- ❑ When you use originals of fine letters, letters on prints may be skipped. In this case, increase the image density or use Letter mode.
- ❑ Since some parts of the machine are supplied with high voltage, touch only the parts specified in this manual.
- ❑ Do not spill liquid on the machine.
- ❑ When removing the drum unit from the machine, be careful not to let the drum unit fall.
- ❑ Always turn the machine off when you have finished printing for the day.
- ❑ If you clean rubber parts with benzine, wipe them with a dry cloth afterwards.
- ❑ While printing, do not turn off the main switch.
- ❑ While printing, do not unplug the power cord.
- ❑ While printing, do not open the door or covers.
- ❑ While printing, do not move the machine.
- ❑ Open and close the door and covers softly.
- ❑ Do not modify or replace any parts other than the ones specified in this manual.
- ❑ Do not operate the machine without covers. You might get your fingers caught in the machine, or the machine might be damaged because, for example, dust or the like might get inside.
- ❑ Since some parts of the machine are sharp and might cause injury, touch only the parts specified in this manual.

Print Paper

- When the paper is curled, stack the paper with the curl face down, otherwise the paper might wrap around the drum or stains may appear.

Originals

- If there is no margin or if there is a solid image area near the leading edge of the original, make at least a 5 mm, 0.2" margin at the leading edge; otherwise, the paper might wrap around the drum or the paper exit pawl might become dirty and cause black lines on prints.
- If you use paste-up originals, select Paste Shadow Erase mode (☛ see page 36) and make sure that the pasted parts hold firmly to the base sheet. If the thickness of the paste-up originals is more than 0.1 mm and the space between the pasted parts is less than 2 mm, 2/25", a shadow might appear on the print.
- If you use originals that have bold letters or solid images at the leading edges, you might get prints with dirty edges. In this case, insert the widest margin first, or raise the printing speed.

COMBINATION CHART

This combination chart shows which modes can be used together.

○: means that these modes can be used together.

✕: means that these modes cannot be used together.

☆: means that some functions in these modes cannot be used together.

		1	2	3	4	5	6	7	8	9	10	11
1	Reduction		✕	○	○	○	○	○	○	✕	○	○
2	Enlargement	✕		○	○	○	○	○	○	✕	○	○
3	Auto Cycle	○	○		○	○	○	○	○	☆	☆	○
4	One Touch Class	○	○	○		○	○	○	○	○	○	○
5	Combine 2 Originals	○	○	○	○		○	○	○	✕	✕	○
6	Margin Erase	○	○	○	○	○		○	○	✕	○	○
7	Type of Original (Letter/Photo)	○	○	○	○	○	○		○	✕	○	○
8	Image Density	○	○	○	○	○	○	○		✕	○	○
9	On-Line	✕	✕	○	☆	✕	✕	✕	✕		○	○
10	Overlay	○	○	○	☆	✕	○	○	○	○		○
11	Economy mode/Tint mode	○	○	○	○	○	○	○	○	○	○	

SPECIFICATIONS

Main Frame

Configuration:	Desk top
Printing Process:	Full automatic one drum system
Original Type:	Sheet/Book
Original Size:	Maximum 257 mm x 364 mm, 10.2" x 14.4"
Pixel Density:	300 dpi
Image Mode:	Photo mode (Sand pattern) Letter mode (Standard mode) Letter/Photo mode
Reduction Ratios:	Inch version: 93%, 77%, 74%, 65% Metric version: 93%, 87%, 82%, 71%
Enlargement Ratios:	Inch version: 155%, 129%, 121% Metric version: 141%, 122%, 115%
Printing Area:	<B4 drum> More than 250 mm x 355 mm, 9.8" x 14.0" <A4 drum> More than 210 mm x 288 mm, 8.2" x 11.3"
Print Paper Size:	Maximum 297 mm x 432 mm, 11.6" x 17.0" Minimum 90 mm x 148 mm, 3.6" x 5.9"
Leading Edge Margin:	5 mm \pm 3 mm, 0.2" \pm 0.12"
Print Paper Weight:	47.1 g/m ² to 209.3 g/m ² , 12.5 lb to 55.6 lb
Print Speed:	60 - 120 rpm (5 steps)
First Copy Time (Master Process time):	Less than 26.0 seconds (B4 <input type="checkbox"/> , 8 1/2" x 14" <input type="checkbox"/>) Less than 25.0 seconds (A4 <input type="checkbox"/> , 8 1/2" x 14" <input type="checkbox"/>) (When setting an original on the exposure glass)
Second Copy Time (First Print Time):	Less than 28.0 seconds (B4 <input type="checkbox"/> , 8 1/2" x 14" <input type="checkbox"/>) Less than 27.0 seconds (A4 <input type="checkbox"/> , 8 1/2" x 11" <input type="checkbox"/>) (When setting an original on the exposure glass)

Color Printing: Drum unit replacement system
(black, red, blue, green, brown, yellow, purple, navy, maroon, orange and teal)

Image Position Adjustment: Horizontal:
More than 20 mm, 0.79" (for either side)
Vertical:
More than 10 mm, 0.39" (on both sides)

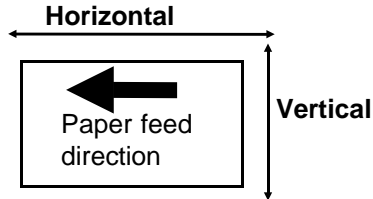

Paper Feed Table Capacity: 1,000 sheets
(80 g/m², 20 lb)

Paper Delivery Table Capacity: When lifting the wing guides: 800 sheets
When lowering the wing guides: 1,000 sheets
(64 g/m², 17 lb)

Master Eject Box Capacity: More than 60 masters under low temperature
More than 70 masters at 23°C, 73°F

Dimensions (W x D x H):

	Width	Depth	Height
Stored	685 mm, 27"	625 mm, 24.6"	620 mm, 24.4"
Stored with document feeder	685 mm, 27"	625 mm, 24.6"	670 mm, 26.4"
Set up	1,285 mm, 50.6"	625 mm, 24.6"	620 mm, 24.4"
Set up with cabinet	1,285 mm, 50.6"	625 mm, 24.6"	1,085 mm, 42.7"
Set up with document feeder	1,285 mm, 50.6"	625 mm, 24.6"	670 mm, 26.4"
Set up with cabinet and document feeder	1,285 mm, 50.6"	625 mm, 24.6"	1,135 mm, 44.7"

Weight: Main frame: 95 kg, 209.5 lb
Main frame with optional document feeder: 98 kg, 216.1 lb

Noise Emission:

Sound power level (The measurements are made according to ISO 7779.)

Printing Speed	
60 rpm	73.6 dB (A)
90 rpm	77.6 dB (A)
120 rpm	80.2 dB (A)

Sound pressure level (The measurements are made according to ISO 7779 at the operator position.) **Less than 70 dB (A)**

Printing Speed	
60 rpm	60.4 dB (A)
90 rpm	64.8 dB (A)
120 rpm	67.6 dB (A)

Power Source: See the inside front cover of this manual.

Power Consumption:

Power Source*	120 V	220 - 240 V
Stand-by	Less than 65 W	Less than 85 W
Master Making	Less than 310 W	Less than 340 W
Printing: Speed 1	Less than 245 W	Less than 275 W
Speed 3	Less than 275 W	Less than 270 W
Speed 5	Less than 325 W	Less than 320 W

*To check the power source of your machine, see the inside front cover of this manual.

Optional Equipment: Color Drum - red, blue, green, brown, yellow, purple, navy, maroon, orange and teal
Key Counter
Tape Dispenser
Cabinet
Document Feeder

Specifications are subject to change without notice.

Document Feeder (Option)

Original Type:	Sheet
Original Weight:	When setting a stack of originals: 50 ~ 90 g/m ² , 13.3 ~ 23.9 lb When setting one sheet at a time: 40 ~ 120 g/m ² , 10.6 ~ 31.9 lb
Original Size:	Max. 257 mm x 364 mm, 10.2" x 14.4" Min. 148 mm x 105 mm, 5.8" x 4.1"
First Copy Time (Master Process Time):	Less than 29.0 seconds (B4, 8 1/2" x 14") Less than 28.0 seconds (A4, 8 1/2" x 11")
Second Copy Time (First Print Time):	Less than 32.0 seconds (B4, 8 1/2" x 14") Less than 31.0 seconds (A4, 8 1/2" x 11")
Original Capacity:	30 sheets (80 g/m ² , 20 lb)

- Specifications are subject to change without notice.

Consumables

Name	Size	Remarks
Master for B4 drum	Length: 125m, 410 ft/roll Width: 280 mm, 11.0" 2 Rolls/case	257 masters can be made per roll
Master for A4 drum	Length: 125m, 410 ft/roll Width: 240 mm, 9.5" 2 Rolls/case	290 masters can be made per roll
Ink-Black	1,000 ml/pack, 600 ml/pack, 5 packs/case	Environmental conditions: - 5 ~ 40°C 10 ~ 95 % RH
Ink-Red	600 ml/pack, 5 packs/case	
Ink-Blue	600 ml/pack, 5 packs/case	
Ink-Green	600 ml/pack, 5 packs/case	
Ink-Brown	600 ml/pack, 5 packs/case	
Ink-Yellow	600 ml/pack, 5 packs/case	
Ink-Purple	600 ml/pack, 5 packs/case	
Ink-Navy	600 ml/pack, 5 packs/case	
Ink-Maroon	600 ml/pack, 5 packs/case	
Ink-Orange	600 ml/pack, 5 packs/case	
Ink-Teal	600 ml/pack, 5 packs/case	
Tape for Tape dispenser	35m (114.8 ft)/roll	

- Specifications are subject to change without notice.

INDEX

A

Access program, 75
 Access Service Program, 94
 Access To The Machine, 8
 ADF Unit, 82
 ADF Unit Open Lever, 82
 Adjust the image density, 23
 Adjusting The Image Position, 21
 After clearing misfeeds, 131
 Auto Class mode, 101
 Auto Cycle, 45
 Auto Cycle key, 5, 45
 Auto Multi Copy mode, 100

B

Black line/stain, 155

C

Change paper size on the paper feed table, 118
 Change settings of SP mode, 95
 Change speed, 24
 Change the drum unit, 89
 CHANGING DEFAULT SETTINGS, 94 - 115
 Clear key, 6
 Clear Modes key, 6
 Color Drum indicator, 7, 88
 Color Printing, 88
 COMBINATION CHART, 161
 Combine 2 Originals, 63
 Combine 2 Originals key, 6, 63
 Combine 2 originals with DF, 85
 Consumables specifications, 166
 CS mode keys, 5, 98

D

DAILY MAINTENANCE, 126 - 127
 Exposure glass, 126
 Paper feed roller, 127

Platen cover, 126
 Separation roller, 127
 Dirty background, 153
 Document Feeder, 82
 Drum rotation button, 4
 Drum unit, 4
 Drum unit lock lever, 4

E

E-XX, 130
 Economy Mode, 42
 Economy/Tint key, 5, 42 - 43
 Edge Erase key, 5, 34
 Edge Erase/Center Erase key, 5, 31
 Enlarge key, 5, 29
 Enlargement, 29
 Enter key, 6
 Erase Center and Edge Margins, 31
 Erasing Edge Margins, 34
 Error indicators, 7

F

Feed roller pressure lever, 2
 Front cover, 2
 Full Size key, 6

G

Guidance display, 7
 Guide to document feeder, 82

I

Image Density key, 5, 23
 Image Position keys, 6, 21
 Ink holder, 4
 Ink, supplying, 119
 Input a program, 73
 INSTALLATION REQUIREMENTS, 8 - 9
 Access To The Machine, 8
 Environments To Avoid, 8

Optimum Environmental Conditions, 8
Power Connection, 9

L

Load paper on the paper feed table,
116
Lower key, 6

M

Machine Exterior, 1
Machine Interior, 3
Main frame specifications, 162
Main switch, 4
Master cut button, 4
Master eject container cover, 4
Master Eject indicator, 150
Master eject unit open button, 4
Master Making indicator, 7
Master Making/Print key, 5
Master Roll Replacement, 121
Misfeed indicator, 128, 131

N

Number keys, 6

O

One Touch Class key, 47
One Touch Class Mode, 47
 Multi-programming, 52
 Simple programming, 50
One Touch Class mode with DF, 87
Open cover/unit indicator, 129, 148
OPERATION, 10 - 81
OPERATION NOTES, 158 - 160,
162, 164, 166
Operation panel, 2, 5
OPTIONAL FUNCTIONS, 82 - 93
Original Guides, 82
Original Misfeed, 132
Original table release lever, 2
Original Tray, 82
Originals, 11
Originals for document feeder, 83

P

Paper delivery end plate, 4
Paper delivery side plate, 4
Paper delivery table, 4
Paper feed side plates, 2
Paper feed table, 2
paper size detection, 103
Paste Shadow Erase, 36
Paste Shadow Erase key, 5, 36
Photo Background Correct, 99
Photo mode, 40
Place a roll of tape in the tape dispenser, 124
Plate, 2
Platen cover, 2
Poor Printing, 153
Power Connection, 9
Preparation For Printing, 12
Pressure release lever, 4
Print indicator, 7
Print on thick paper, 38
Print on thin paper, 39
Printing on thick paper, 38
Printing Paper, 10
Program Class key, 6, 47
Program key, 6, 73
Proof key, 6

Q

Quality Start key, 5

R

Recuction, 27
Reduce key, 5, 27 - 28, 30
Reduction/Enlargement Printing, 27
 Enlargement, 29
 Reduction, 27
Register program, 73
REPLENISHING SUPPLIES,
 116 - 125
Reset key, 6, 131
Restore The Tables, 19

S

SAFETY INFORMATION, i - iv
Save ink, 42
Security key, 5, 79
Security mode, 79
Separation roller pressure lever, 2
Service Program Menu, 102
SERVICE PROGRAM MODE,
94 - 115
Set the key counter, 152
Setting up the paper delivery table,
13
Shift image, 21 - 22
Side plate fine adjusting dial, 2, 22
Skip Feed key, 5, 71
Skip Feed Printing, 71
Small size paper delivery end plate, 4
SP Mode, 94
SP mode key, 5
SPECIFICATIONS, 162 - 167
Speed indicators, 7
Speed keys, 6, 24
Standard printing, 16
Start key, 6
Stop key, 6, 25
Stop The Operation, 25
Supply/Exchange indicators, 129, 150
Supplying ink, 119

T

Tape Dispenser, 124
Thick paper, 38
Thin paper, 39
Tint Mode, 43
TROUBLESHOOTING, 128 - 157
Two colors printing, 92
Type of Original, 40
Type of Original key, 5, 40

U

User Codes, 109
Checking the user code counter, 112
Clearing the user code counter, 113

Clearing the user code total counter,
115
Enabling user code mode, 109
Using user code mode, 111
User Program, 73

W

White or incomplete prints, 156